



US007261857B2

(12) **United States Patent**
Suslick et al.

(10) **Patent No.:** **US 7,261,857 B2**
(45) **Date of Patent:** ***Aug. 28, 2007**

(54) **COLORIMETRIC ARTIFICIAL NOSE HAVING AN ARRAY OF DYES AND METHOD FOR ARTIFICIAL OLFACTION**

(75) Inventors: **Kenneth S. Suslick**, Champaign, IL (US); **Neal A. Rakow**, Champaign, IL (US); **Avijit Sen**, Urbana, IL (US); **William B. McNamara, III**, Urbana, IL (US); **Margaret E. Kosal**, Champaign, IL (US)

(73) Assignee: **The Board of Trustees of the University of Illinois**, Urbana, IL (US)

(*) Notice: Subject to any disclaimer, the term of this patent is extended or adjusted under 35 U.S.C. 154(b) by 534 days.

This patent is subject to a terminal disclaimer.

(21) Appl. No.: **10/279,788**

(22) Filed: **Oct. 24, 2002**

(65) **Prior Publication Data**

US 2003/0143112 A1 Jul. 31, 2003

Related U.S. Application Data

(63) Continuation-in-part of application No. 09/705,329, filed on Nov. 3, 2000, now Pat. No. 6,495,102, which is a continuation-in-part of application No. 09/532,125, filed on Mar. 21, 2000, now Pat. No. 6,368,558.

(51) **Int. Cl.**
G01N 21/00 (2006.01)

(52) **U.S. Cl.** **422/55**; 422/68.1; 422/82.05; 422/83; 422/85; 436/164; 436/172

(58) **Field of Classification Search** 422/55, 422/68.1, 82.05-82.11, 83, 85, 86; 436/164, 436/165, 172

See application file for complete search history.

(56) **References Cited**

U.S. PATENT DOCUMENTS

4,759,210 A 7/1988 Wohltjen

(Continued)

FOREIGN PATENT DOCUMENTS

EP 0352610 A2 1/1990

OTHER PUBLICATIONS

Krishna Persaud & George Dodd, "Analysis of Discrimination Mechanisms in the Mammalian Olfactory System using a Model Nose," Nature vol. 299, Sep. 23, 1982, pp. 352-355.

(Continued)

Primary Examiner—Jill Warden

Assistant Examiner—Dwayne K. Handy

(74) *Attorney, Agent, or Firm*—Licata & Tyrrell P.C.

(57) **ABSTRACT**

The present invention involves an artificial nose having an array comprising at least a first dye and a second dye in combination and having a distinct spectral response to an analyte. In one embodiment, the first and second dyes are from the group comprising chemoresponsive dyes, and the second dye is distinct from the first dye. In one embodiment, the first dye is selected from the group consisting of porphyrin, chlorin, chlorophyll, phthalocyanine, and salen, or their metal complexes. In another embodiment, the second dye is selected from the group of dyes consisting of acid-base indicator dyes and solvatochromic dyes. The present invention is particularly useful in detecting metal ligating vapors. Further, the array of the present invention can be connected to a visual display device.

22 Claims, 21 Drawing Sheets
(13 of 21 Drawing Sheet(s) Filed in Color)

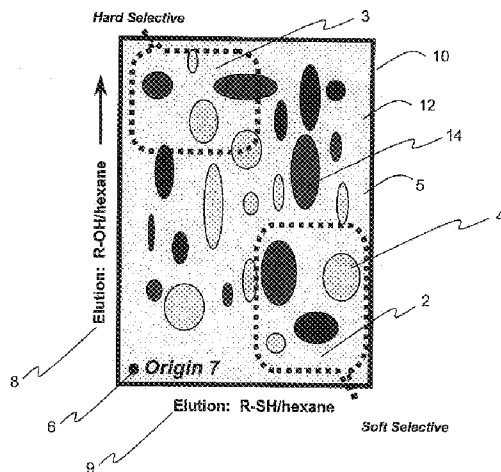

U.S. PATENT DOCUMENTS

4,907,441 A	3/1990	Shurmer	
5,489,988 A	2/1996	Ackley et al.	
5,512,490 A	4/1996	Walt et al.	
5,733,506 A	3/1998	Silver et al.	
5,786,219 A	7/1998	Zhang et al.	
5,814,524 A	9/1998	Walt et al.	
5,834,626 A	11/1998	De Castro et al.	
5,863,460 A	1/1999	Slovacek et al.	
5,952,237 A	9/1999	Tanaka et al.	
5,955,603 A	9/1999	Therien et al.	
5,994,150 A	11/1999	Challener et al.	
6,078,705 A	6/2000	Neuschafer et al.	
6,140,138 A	10/2000	Bard et al.	
6,210,910 B1*	4/2001	Walt et al.	435/7.32
6,331,438 B1*	12/2001	Aylott et al.	436/172
6,368,558 B1	4/2002	Suslick et al.	
6,387,709 B1*	5/2002	Mason et al.	436/164
6,395,558 B1*	5/2002	Duveneck et al.	436/172
6,429,027 B1*	8/2002	Chee et al.	436/518
6,490,030 B1*	12/2002	Gill et al.	356/71
6,492,182 B1*	12/2002	Bright et al.	436/172
6,495,102 B1*	12/2002	Suslick et al.	422/55
6,512,580 B1*	1/2003	Behringer et al.	356/244
6,649,416 B1*	11/2003	Kauer et al.	436/164
6,713,260 B2*	3/2004	Tomich et al.	435/6
6,859,570 B2*	2/2005	Walt et al.	385/12

OTHER PUBLICATIONS

- Janet Kavandi, James Callis, Martin Gouterman, Gamai Khalil, Daniel Wright, "Luminescent Barometry in Wind Tunnels," *Rev. Sci. Instrum.*, vol. 61, No. 11, Nov. 1990, pp. 3340-3347.
- Jay W. Grate and Michael H. Abraham, "Solubility Interactions and the Design of Chemically Selective Sorbent Coatings for Chemical Sensors and Arrays," *Sensors and Actuators B*, 3 (1991) pp. 85-111.
- Julian W. Gardner, Harold V. Shurmer and Paul Corcoran, "Integrated Tin Oxide Odour Sensors," *Sensors and Actuators B*, 4 (1991) pp. 117-121.
- J. W. Gardner, H. V. Shurmer, and T. T. Tan, "Application of an Electronic Nose to the Discrimination of Coffees," *Sensors and Actuators B*, 6 (1992) pp. 71-75.
- Alan E. Baron, J.D.S. Danielson, Martin Gouterman, Jiang River Wan, "Submillisecond Response Times of Oxygen-Quenched Luminescent Coatings," *Rev. Sci. Instrum.* 64 (12) Dec. 1993, pp. 3394-3402.
- Weekey Wai-San Lee, Kwok-Yin Wong, Xiang-Ming Li, Yiu-Bong Leung, Chi-Shing Chan and Kin Shing Chan, Halogenated Platinum Porphyrins as Sensing Materials for Luminescence-Based Oxygen Sensors, *J. Mater. Chem.* 1993, pp. 1031-1035.
- Julian W. Gardner and Phillip N. Bartlett, "A Brief History of Electronic Noses," *Sensors and Actuators B*, 18-19 (1994), pp. 211-220.
- Michael S. Freund and Nathan S. Lewis, "A Chemically Diverse Conducting Polymer-Based Electronic Nose," *Proc. Natl. Acad. Sci. USA*, Mar. 1995, vol. 92, pp. 2652-2656.
- Andrea E. Hoyt and Antonio J. Ricco, "Speciation of Linear and Branched Hydrocarbons by a Fluorinated Polyimide Film-Based Surface Acoustic Wave Sensor," *J. Am. Chem. Soc.* 1995, 117, pp. 8672-8673.
- Todd A. Dickinson, Joel White, John S. Kauer and David R. Walt, "A Chemical-Detecting System Based on a Cross-Reactive Optical Sensory Array," *Nature*, vol. 382, Aug. 22, 1996, pp. 697-700.
- Andrew A. Vaughan, Mark G. Baron and Ramaier Narayanaswamy, "Optical Ammonia Sensing Films Based on an Immobilized Metalloporphyrin," *Analytical Communications*, Nov. 1996, vol. 33, pp. 393-396.
- J.A.J. Brunink, et al., "The Application of Metalloporphyrins as Coating Material for Quartz Microbalance-Based Chemical Sensors," *Analytica Chimica ACTA*, 325 (1996) pp. 53-64.
- Brett J. Doleman, Robert D. Sanner, Erik J. Severin, Robert H. Grubbs, and Nathan S. Lewis, "Use of Compatible Polymer Blends to Fabricate Arrays of Carbon Black-Polymer Composite Vapor Detectors," *Analytical Chemistry*, vol. 70, No. 13, Jul. 1, 1998, pp. 2560-2564.
- Richard M. Crooks and Antonio J. Ricco, "New Organic Materials Suitable for Use in Chemical Sensor Arrays," *Accounts of Chemical Research*, vol. 31, No. 5, 1998, pp. 219-227.
- Gregory A. Sotzing, Jennifer N. Phend, Robert H. Grubbs and Nathan S. Lewis, "Highly Sensitive Detection and Discrimination of Biogenic Amines Utilizing Arrays of Polyaniline/Carbon Black Composite Vapor Detectors," *Chem. Mater.* 2000, vol. 12, published on Web Feb. 29, 2000, pp. 593-595.
- Todd A. Dickinson, Karri L. Michael, John S. Kauer and David R. Walt, "Convergent, Self-Encoded Bead Sensor Arrays in the Design of an Artificial Nose," *Anal. Chem.* 1999, vol. 71, Jun. 1, 1999, pp. 2192-2198.
- M.G. Baron, R. Narayanaswamy, S.C. Thorpe, "Hydrophobic Membrane Sensors for the Optical Determination of Hydrogen Chloride Gas," *Sensors and Actuators B* 34 (1996), pp. 511-515.
- Tanaka, et al., Abstract, "Gas-Sensitive Colorants, Gas Sensors and Apparatus and Method for Detecting Gas," Copyright 1999 ACS.
- Suslick, K. S. & Van Deusen-Jeffries, S. in "Comprehensive Supramolecular Chemistry" (ed. Lehn, J.M.) 141-170 (Elsevier Science, Ltd., Oxford, 1996).
- Adler, A. D. et al. "A Simplified Synthesis for meso-Tetraphenylporphin," *J. Org. Chem.* 32, 476 (1967).
- Sen, A. & Suslick, K.S. "Shape Selective Discrimination of Small Organic Molecules," *J. Am. Chem. Soc.*, 1-9, p. S.1 and 2 (In the press).
- Chou, J.-H., Nalwa, H.S., Kosal, M. E., Rakow, N.A. & Suslick, K.S., "Applications of Porphyrins and Metalloporphyrins to Materials Chemistry," From *The Porphyrin Handbook* (eds. Kadish, K., Smith, K., & Guillard, R.) p. 43-132 (Academic Press, New York, 2000).
- Heilig, A. et al., "Gas Identification by Modulating Temperatures of SnO₂-Based Thick Film Sensors," *Sensors and Actuators B* 43, 45-51 (1997).
- Bhyrappa, P., Vaijayanthimala, G. & Suslick, K.S. "Shape-Selective Litigation to Dendrimer-Metalloporphyrins," *J. Am. Chem. Soc.* 121, 262-263 (1999).
- Bhyrappa, P., Young, J.K., Moore, J.S. and Suslick, K.S. "Dendrimer-Metalloporphyrins: Synthesis and Catalysis," *J. Am. Chem. Soc.* 118, 5708-5711 (1996).
- Datta-Gupta, N. & Bardos, T. J. "Synthetic Porphyrins II: Preparation and Spectra of Some Metal Chelates of para-Substituted-meso-Tetraphenylporphines," *J. Pharm. Sci.*, 57, 300-304 (1968).
- Nappa, M. & Valentine, J.S. "The Influence of Axial Ligands on Metalloporphyrin Visible Absorption Spectra. Complexes of Tetraphenylporphinatozinc," *J. Am. Chem. Soc.* 100, 5075-5080 (1978).
- Barley, M., Becker, J. Y., Domazetis, G., Dolphin, D. & James, B. R. "Synthesis and Redox Chemistry of Octaethylporphyrin Complexes of Ruthenium (II) and Ruthenium (III)," *Can. J. Chem.*, 61, 2389-2396 (1983).
- Adler, A. D., Longo, F. R., Kampas, F. & Kim, J. "On the Preparation of Metalloporphyrins," *J. Inorg. Nucl. Chem.* 32, 2443-2445 (1970).
- Di Natale, C. et al. "The Exploitation of Metalloporphyrins as Chemically Interactive Material in Chemical Sensors," *Materials Science & Engineering C5*, 209-215 (1998).
- Walt, D. R. "Fiber Optic Imaging Sensors," *Acc. Chem. Res.* 31, 267-278 (1998).
- Lonegan, M.C. et al. "Array-Based Vapor Sensing Using Chemically Sensitive, Carbon Black-Polymer Resistors," *Chem. Mater* 8, 2298-2312 (1996).
- Axel, R. "The Molecular Logic of Smell," *Science Am.* 273, 154-159 (1995).
- Lancet, D. & Ben-Arie, N. "Olfactory Receptors," *Curr. Biol.* 3, 668-674 (1993).
- Dryer, L. & Berghard A. "Odorant Receptors: A Plethora of G-Protein-Coupled Receptors," *Trends Pharmacol. Sci.* 20, 413-417 (1999).

- Gelperin, A., Flores, J., Raccuia-Behling, F., Cooke, I.R.C., "Nitric Oxide and Carbon Monoxide Modulate Oscillations of Olfactory Interneurons in a Terrestrial Mollusk," *J. Neurophysiol.* 83, 116-127 (2000).
- Holtzen, D., and Gouterman, M., "Transient Absorption Spectra and Excited Kinetics of Transition Metal Porphyrins," *Optical Properties and Structure of Tetrapyrroles*, pp. 63-90 (Blauer, G. & Sund, H. (eds), Walter de Gruyter & Co., Berlin, 1985).
- Yaws, C. L., *Handbook of Vapor Pressure* (Gulf, Houston, 1994), copy not enclosed.
- Suslick, K.S.; Reinert, T. J., The Synthetic Analogs of O₂—Binding Heme Proteins; *Chem Ed.* 1985, vol. 62, pp. 974-982.
- Collman, J. P.; Zhang, X.; Lee, V. J.; Uffelman, E. S.; Brauman, J. I., "Regioselective and Enantioselective Epoxidation Catalyzed by Metalloporphyrins," *Science* 1993, vol. 261, pp. 1401-1411.
- Collman, J. P.; Zhang, X. in *Comprehensive Supramolecular Chemistry*, "Functional Analogues of the Oxygen Binding and Activating Heme Proteins," pp. 1-32.
- Suslick, K.S.; van Deusen-Jeffries, S.; "Biomimetic Shape-Selective Oxidations," vol. 5, pp. 1-30.
- Suslick, K. S. in *Activation and Functionalization of Alkanes; "Shape-Selective Oxidation of Hydrocarbons,"* Hill, C. L., ed.; Wiley & Sons: New York, 1989; pp. 219-241.
- Sheldon, R. A. Ed. Marcel Dekker, *Metalloporphyrins in Catalytic Oxidations*; New York, 1994, cover page and pp. ii through x.
- Bamos, N.; Marvaud, V., Sanders, J. K. M., "Metalloporphyrin Oligomers with Collapsible Cavities: Characterisation and Recognition Properties of Individual Atropisomers," *Chem. Eur. J.* 1998, vol. 4, No. 2, pp. 335-343.
- Stibrany, R. T.; Vasudevan, J.; Knapp, S.; Potenza, J. A.; Emge, T.; Schugar, H. J., "Two Modes of Self-Coordinating Edge-over-Edge Zn(II) Porphyrin Dimerization: A Structural and Spectroscopic Comparison," *J. Am. Chem. Soc.* 1996, vol. 118, pp. 3980-3981.
- Bhyrappa, P.; Vaijayanthimala, G.; Suslick, K. S., "Shape-Selective Ligation to Dendrimer-Metalloporphyrins," *J. Am. Chem. Soc.* 1999, vol. 121, pp. 262-263.
- Imai, H.; Nakagawa, S.; Kyuno, E., "Recognition of Axial Ligands by a Zinc Porphyrin Host on the Basis of Nonpolar Interligand Interaction," *J. Am. Chem. Soc.* 1992, vol. 114, pp. 6719-6723.
- Momenteau, M.; Mispelter, J.; Loock, B.; Bisagni, E., "Both-faces Hindered Porphyrins. Part 1. Synthesis and Characterization of Basket-handle Porphyrins and Their Iron Complexes," *J. Chem. Soc. Perkin Trans. 1*, 1983, pp. 189-196.
- Lindsey, J. S.; Wagner, R. W., "Investigation of the Synthesis of Ortho-Substituted Tetraphenylporphyrins," *J. Org. Chem.* 1989, vol. 54, pp. 828-836.
- Corey, E. J.; Venkateswarlu, A., "Protection of Hydroxyl Groups as *tert*-Butyldimethylsilyl Derivatives," *J. Am. Chem. Soc.* 1972, vol. 94:17, pp. 6190-6191.
- Collman, J. P.; Brauman, J. I.; Doxsee, K. M.; Halbert, T. R.; Hayes, S. E.; Suslick, K. S., "Oxygen Binding to Cobalt Porphyrins," *J. Am. Chem. Soc.* 1978, vol. 100, pp. 2761-2766.
- Suslick, K. S.; Fox, M. M.; Reinert, T., "Influences on CO and O₂ Binding to Iron(II) Porphyrins," *J. Am. Chem. Soc.* 1984, vol. 106, pp. 4522-4525.
- Suslick, K. S.; Cook, B. R., "Regioselective Epoxidations of Dienes with Manganese(III) Porphyrin Catalysts," *J. Chem. Soc., Chem. Comm.* 1987, pp. 200-202.
- Cook, B. R.; Reinert, T. J.; Suslick, K. S., "Shape Selective Alkane Hydroxylation by Metalloporphyrin Catalysts," *J. Am. Chem. Soc.* 1986, vol. 108, pp. 7281-7286.
- Suslick, K. S.; Cook, B. R.; Fox, M. M., "Shape-selective Alkane Hydroxylation," *J. Chem. Soc., Chem. Comm.* 1985, pp. 580-582.
- Suslick, K. S.; Fox, M. M., "A Bis-Pocket Porphyrin," *J. Am. Chem. Soc.*, 1983, vol. 105, pp. 3507-3510.
- Patent Abstracts of Japan; Publication No. 63234137; Publication Date: Sep. 29, 1988.
- Patent Abstracts of Japan; Publication No. 63234138; Publication Date: Sep. 29, 1988.

* cited by examiner

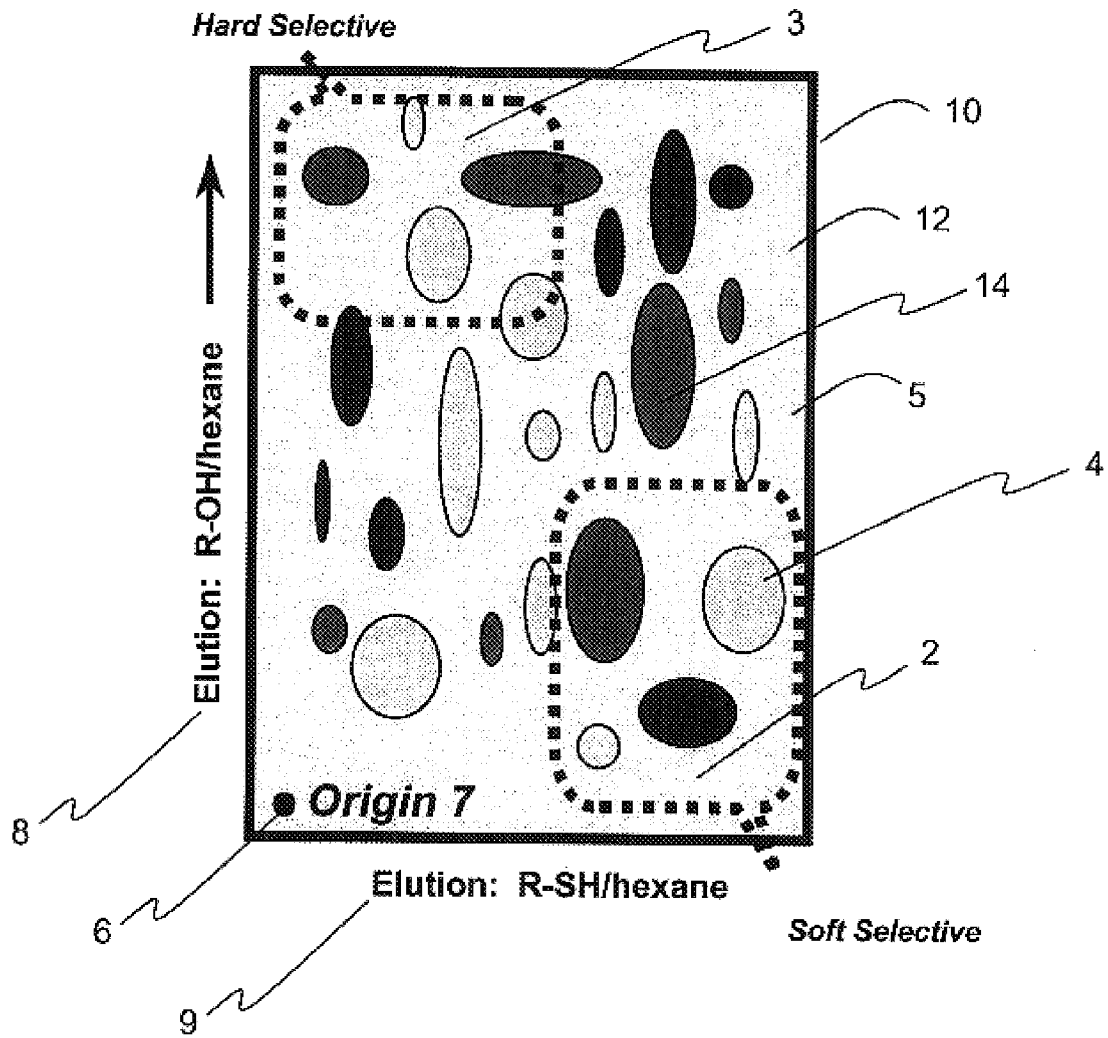
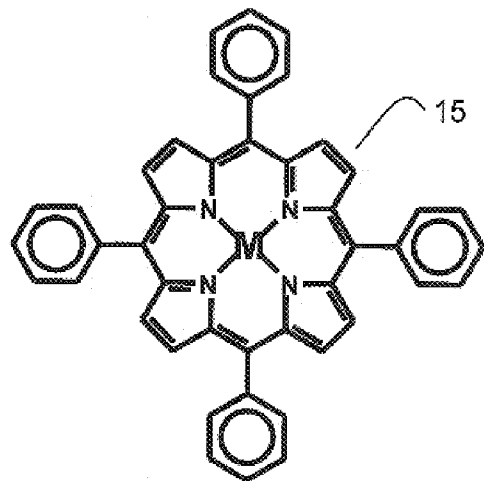

FIG. 1



M(TPP)

<u>Metal</u>	<u>Z/r Ratio (Å⁻¹)</u>
Sn ⁴⁺	5.80
Co ³⁺	5.50
Cr ³⁺	4.88
Mn ³⁺	4.65
Fe ³⁺	4.65
Co ²⁺	3.08
Cu ²⁺	2.74
Ru ²⁺	2.71
Zn ²⁺	2.70
Ag ²⁺	2.13

FIG. 2A

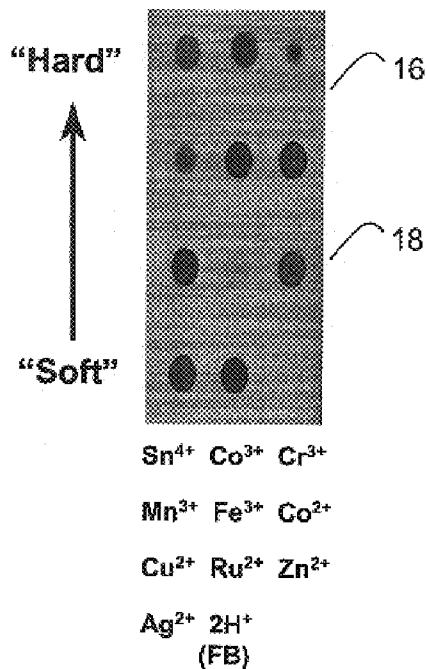

FIG. 2B

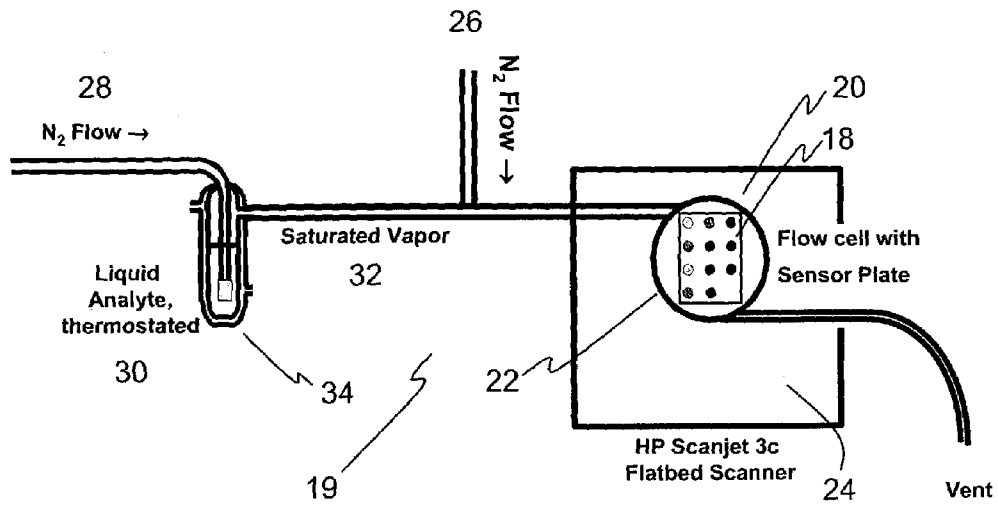

FIG. 3A

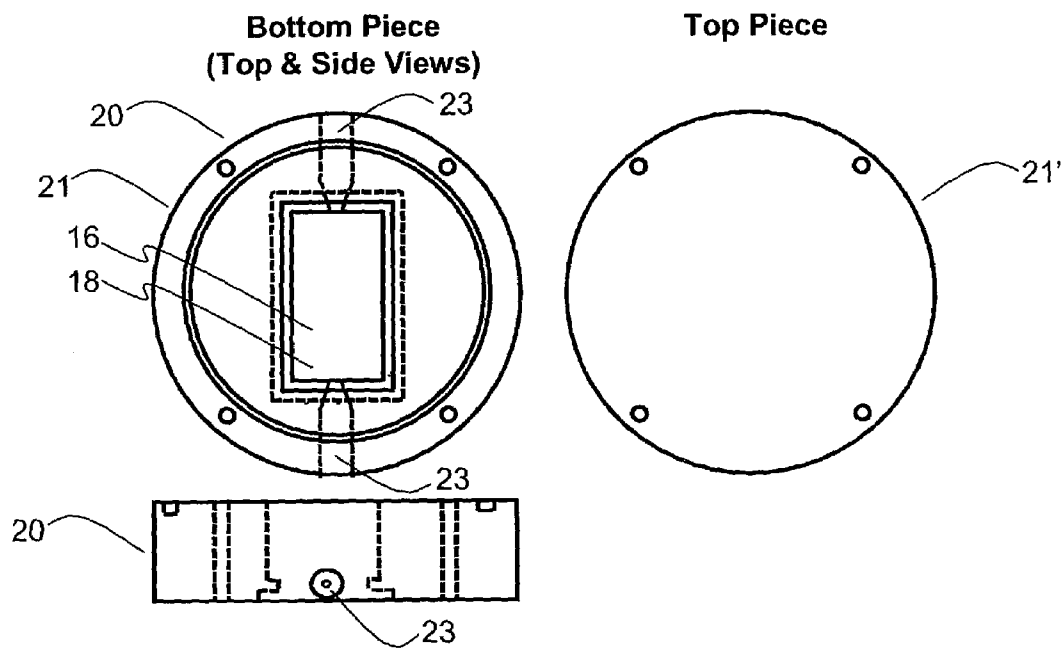

FIG. 3B

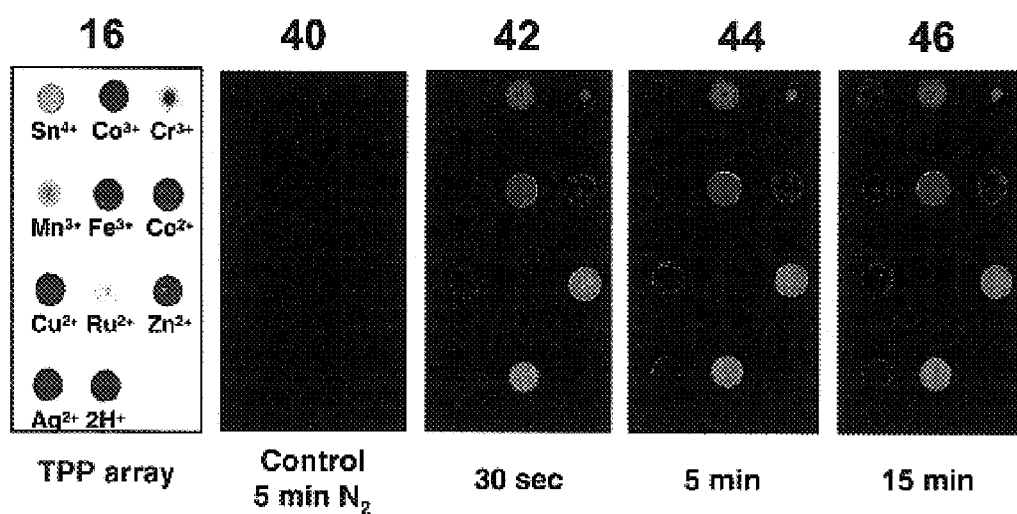

FIG. 4

16

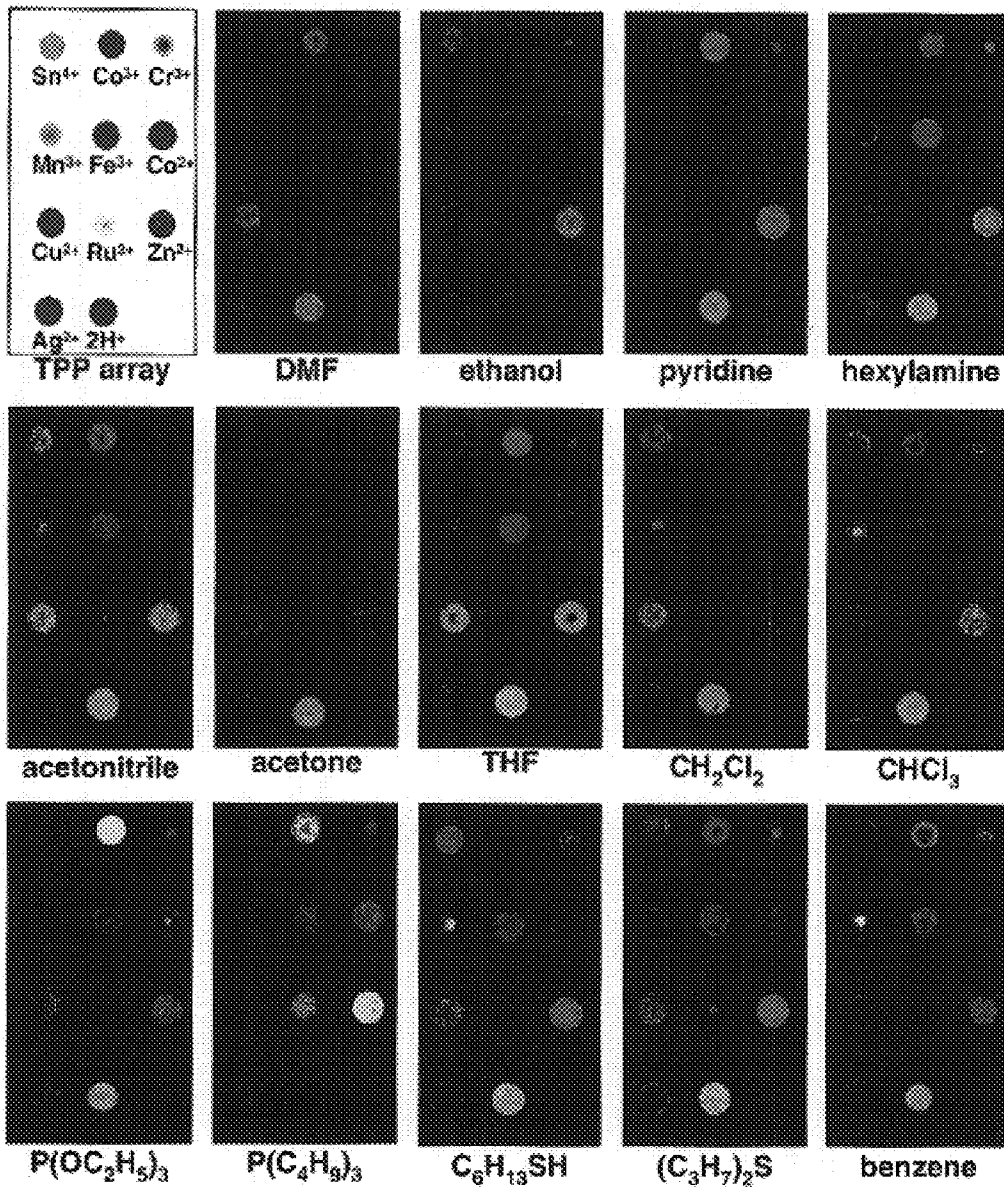

FIG. 5

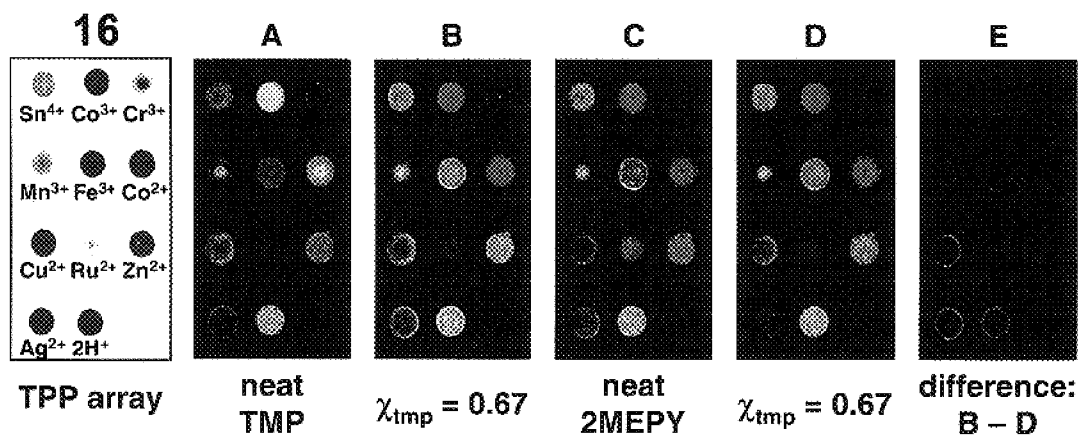

FIG. 6

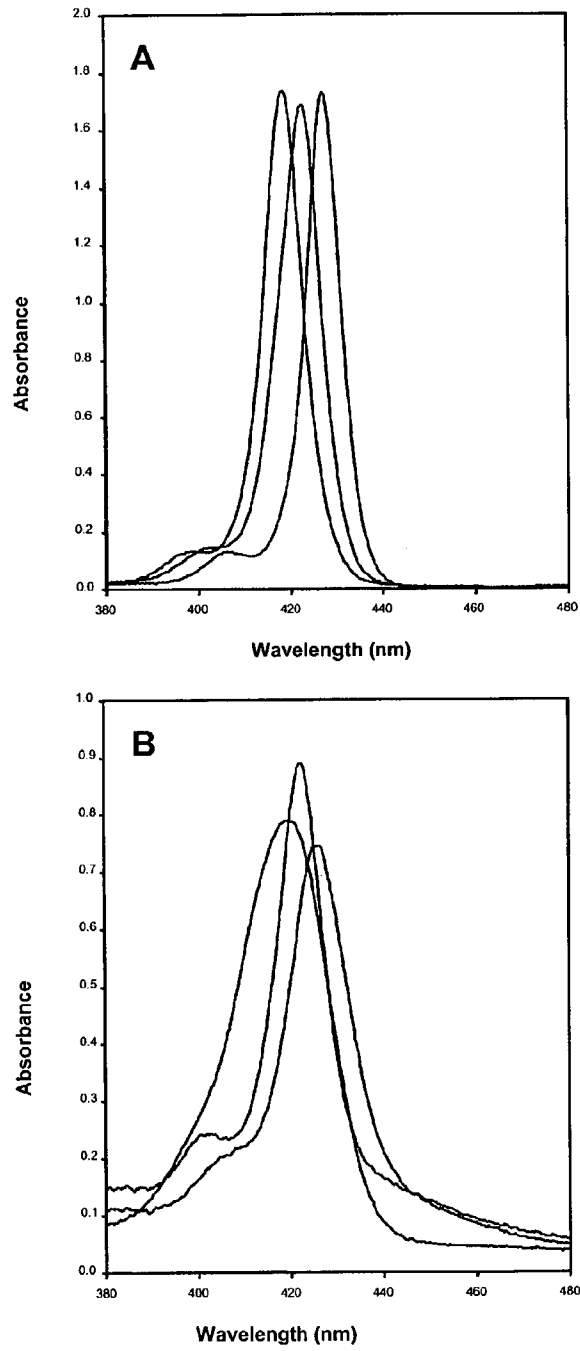

FIG. 7

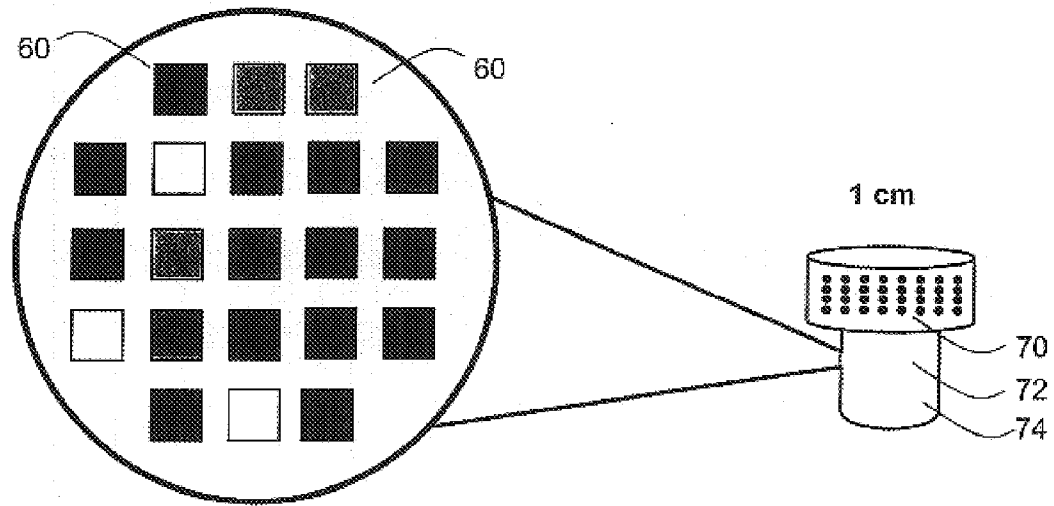

FIG. 8

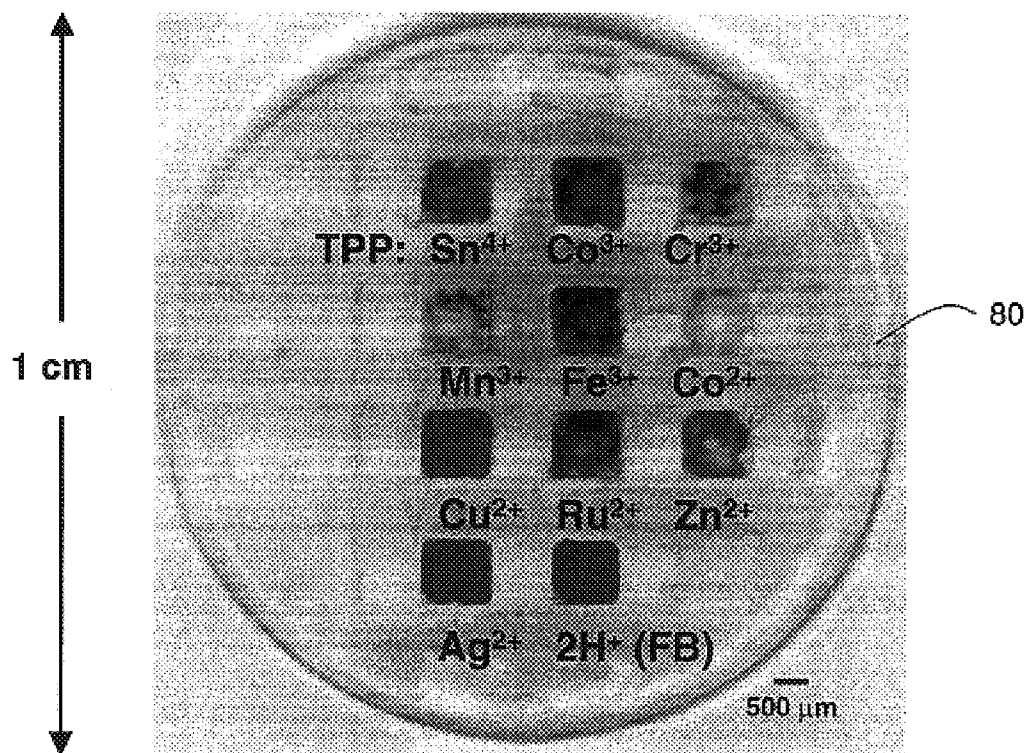

FIG. 9

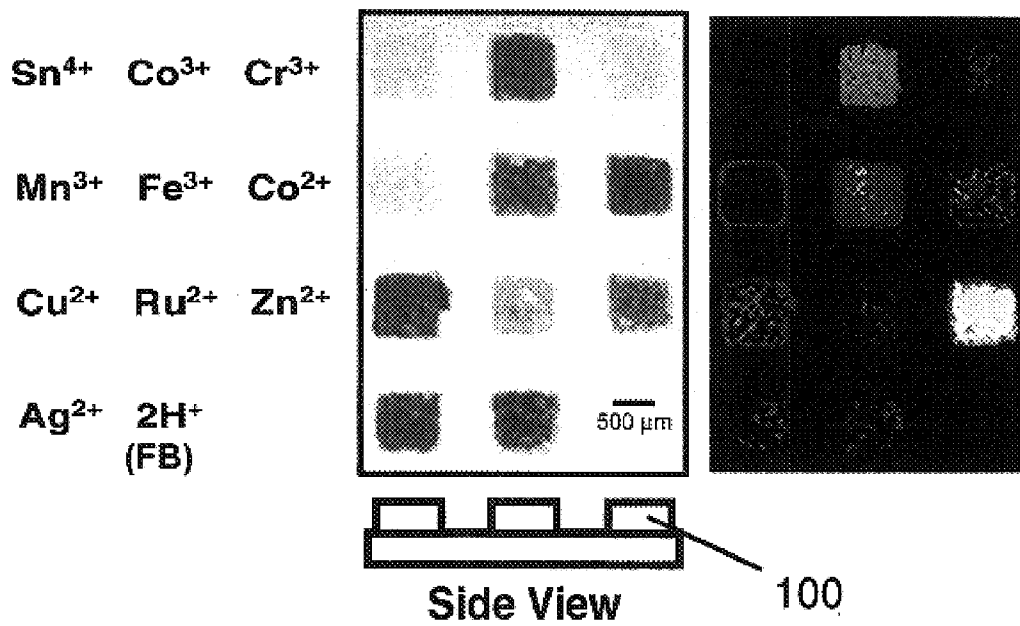

FIG. 10

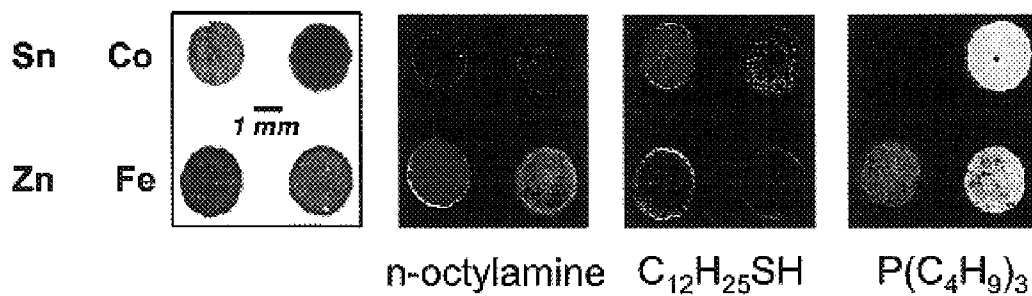

FIG. 11

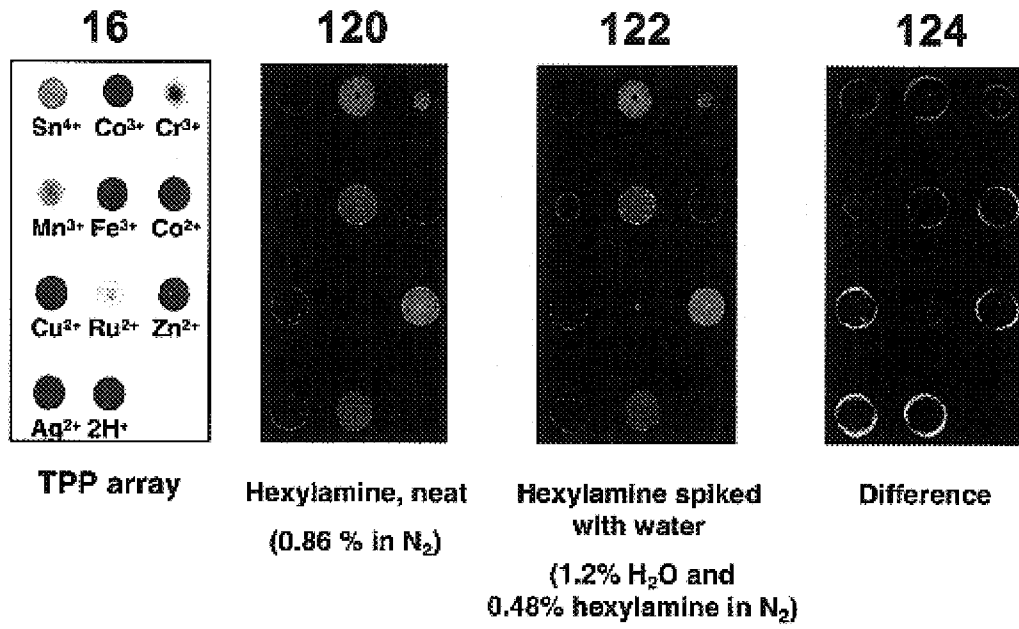

FIG. 12

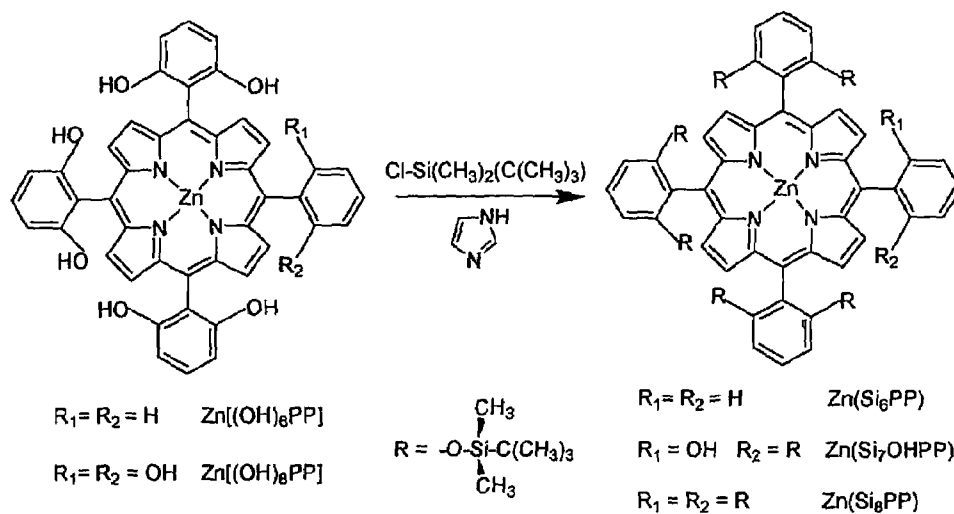
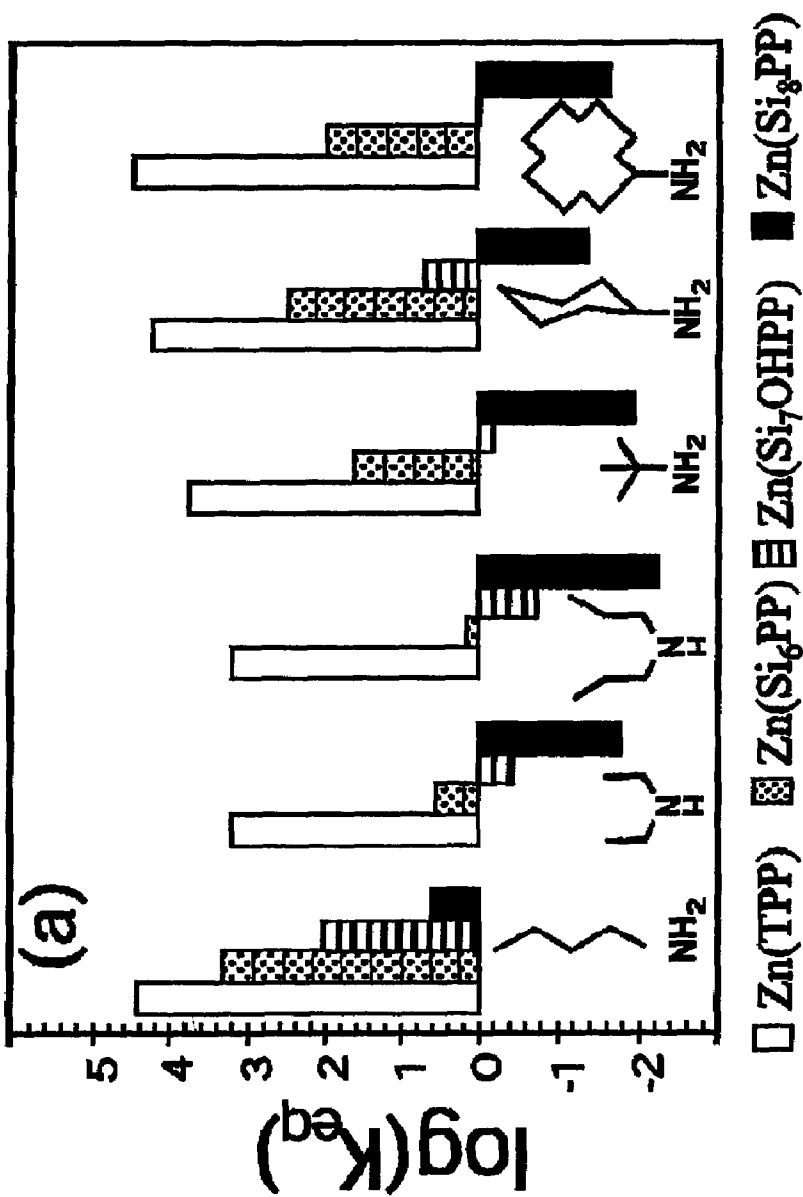

Figure 13

Figure 14a



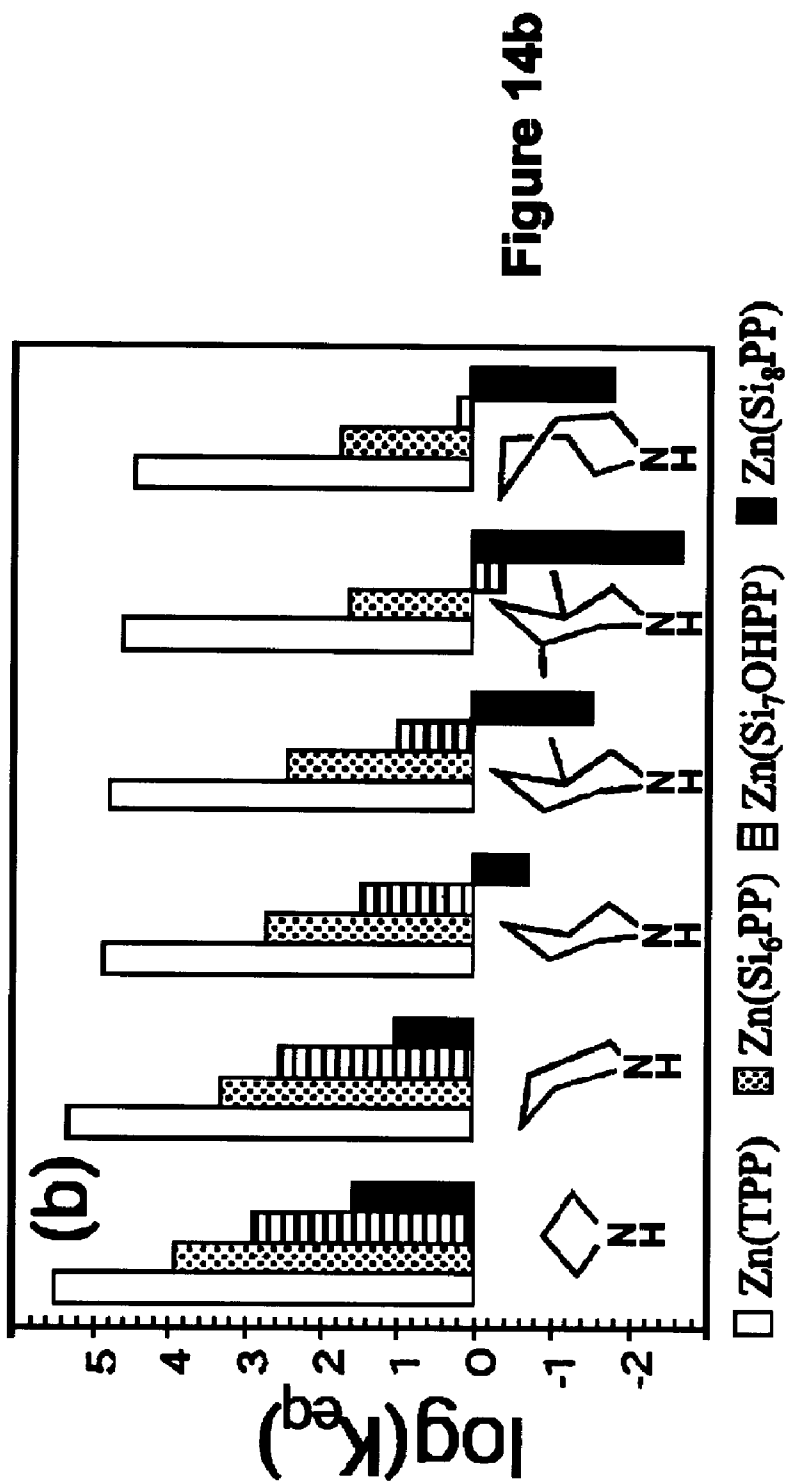
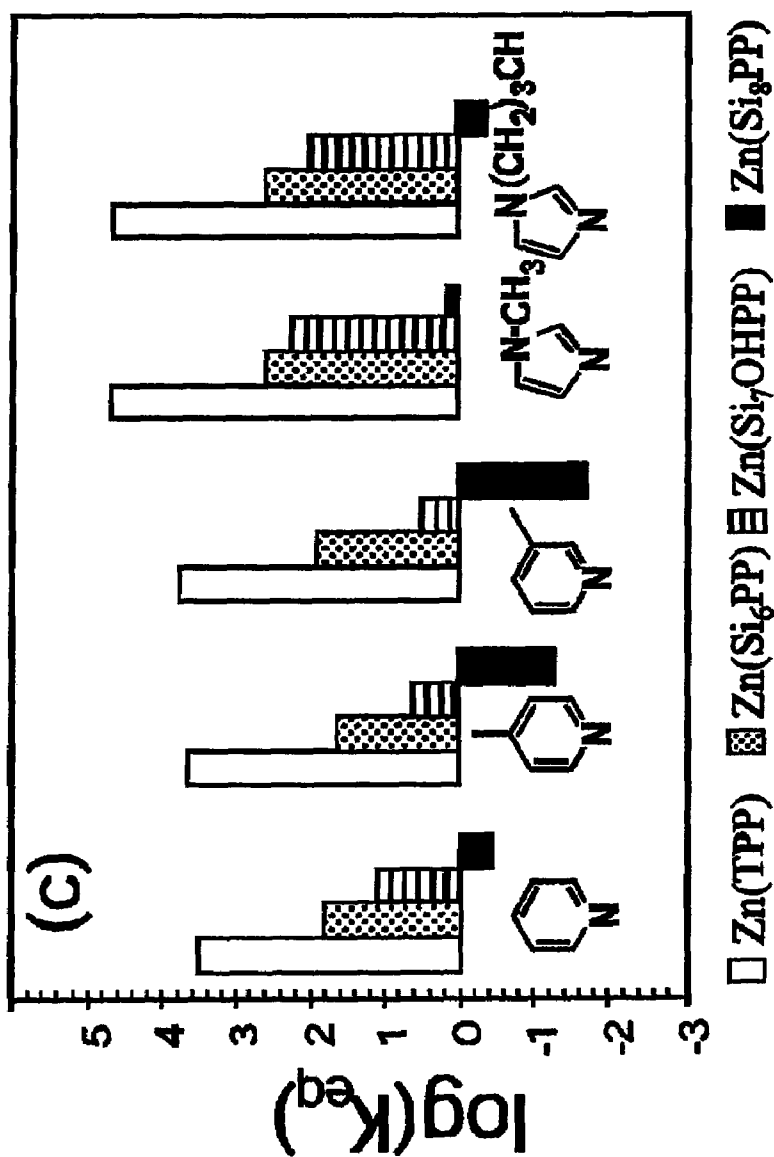

Figure 14c



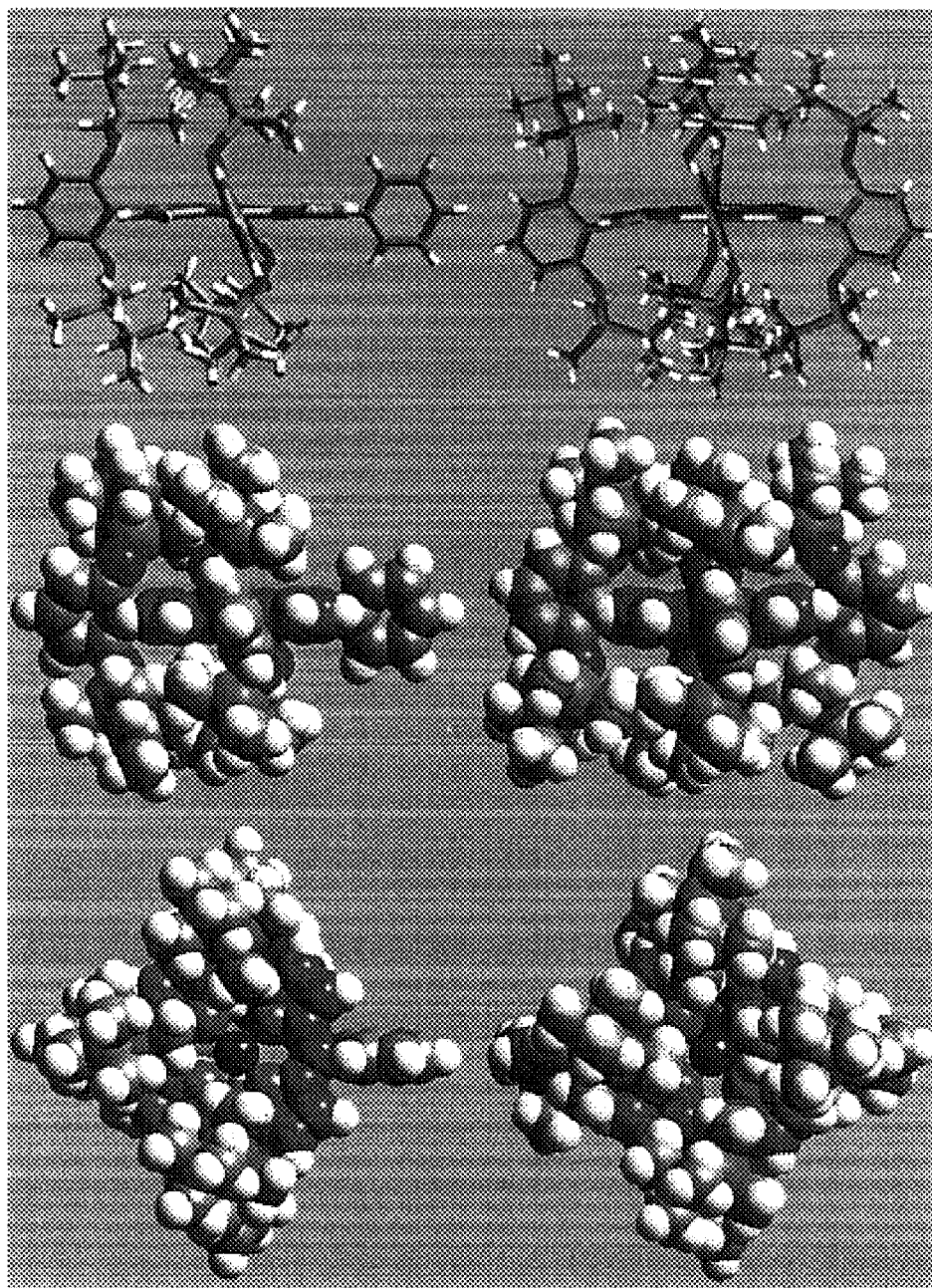

FIG. 15

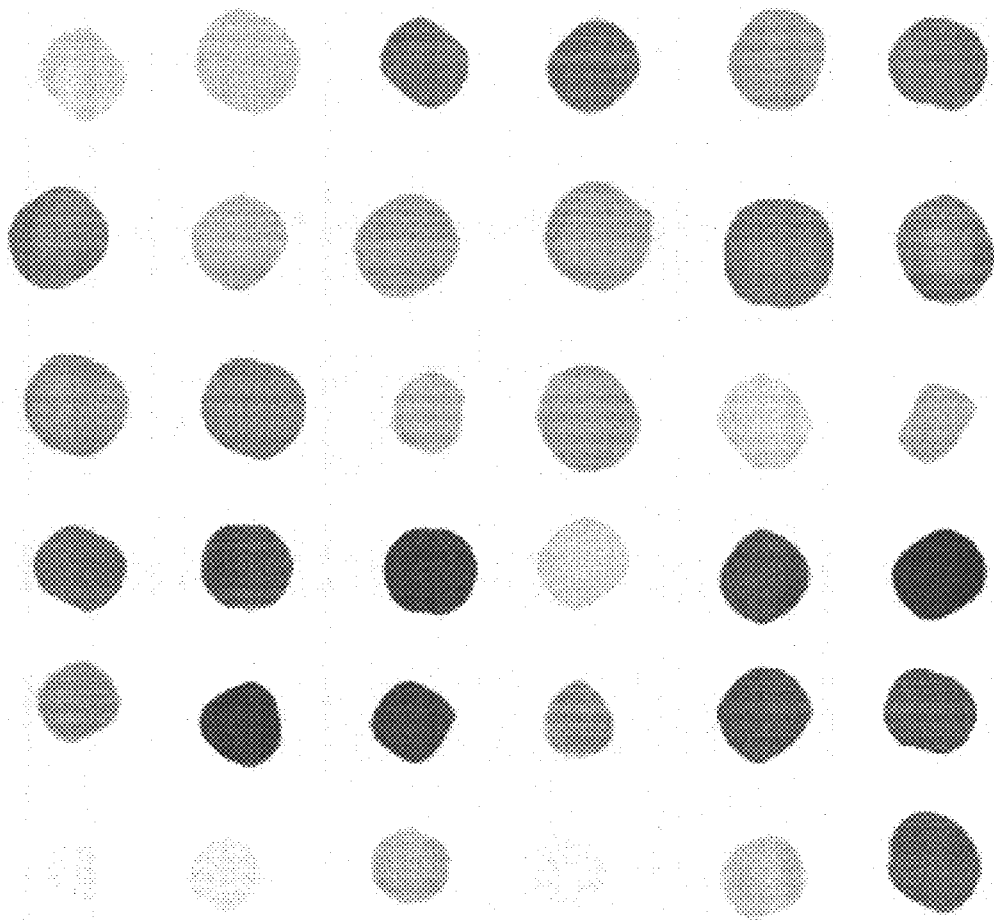

FIG. 16

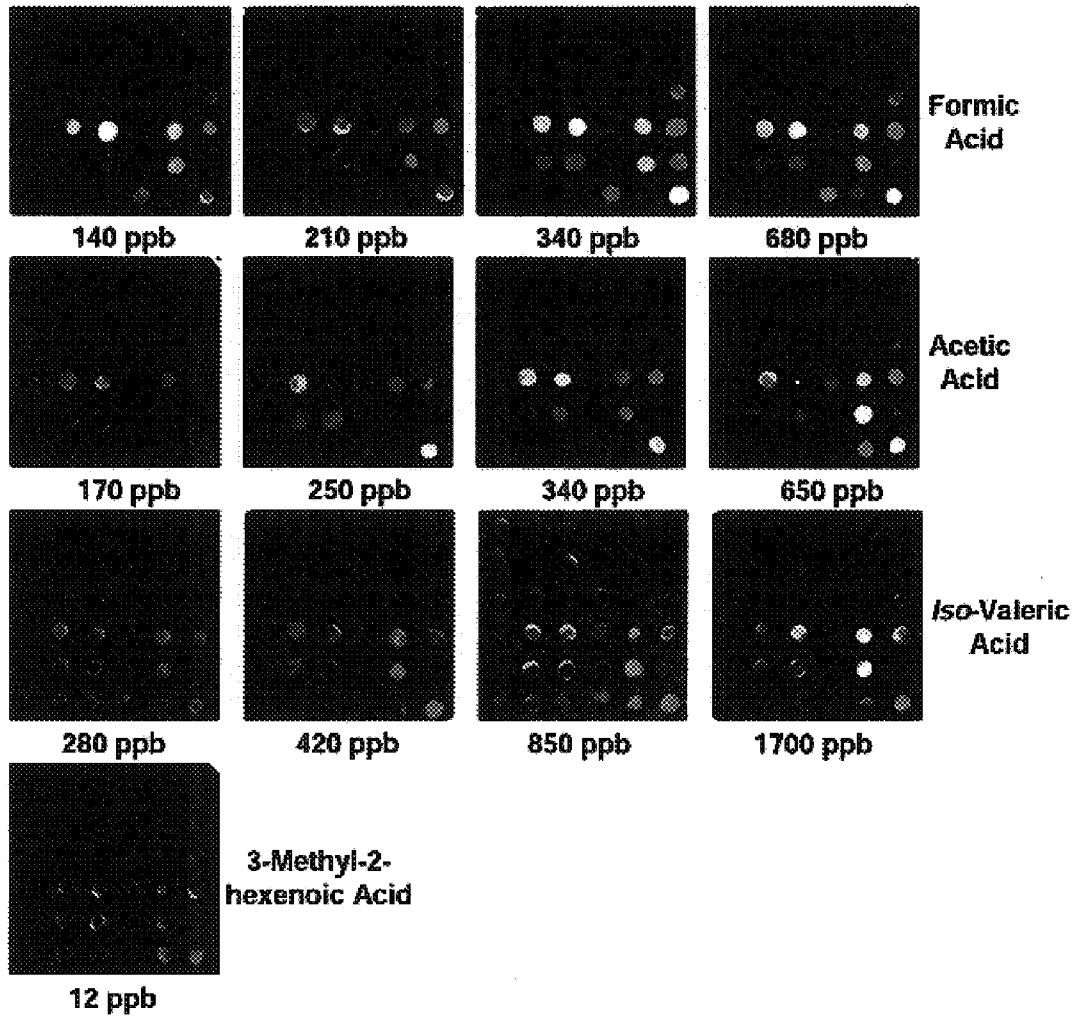

FIG. 17

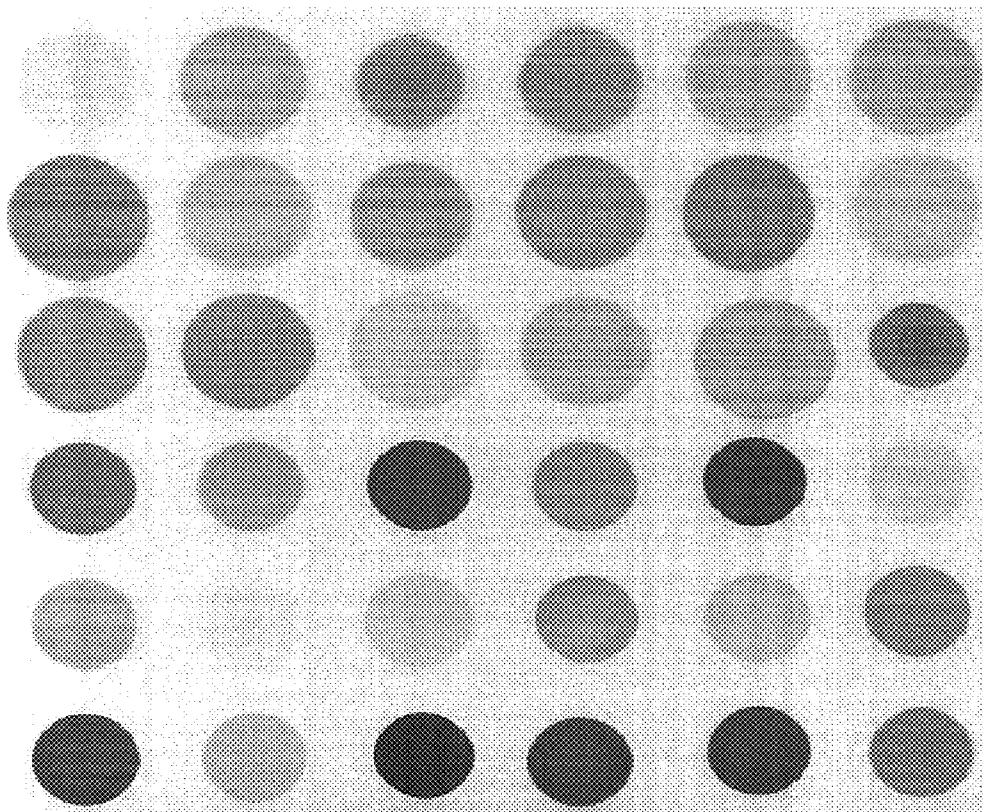
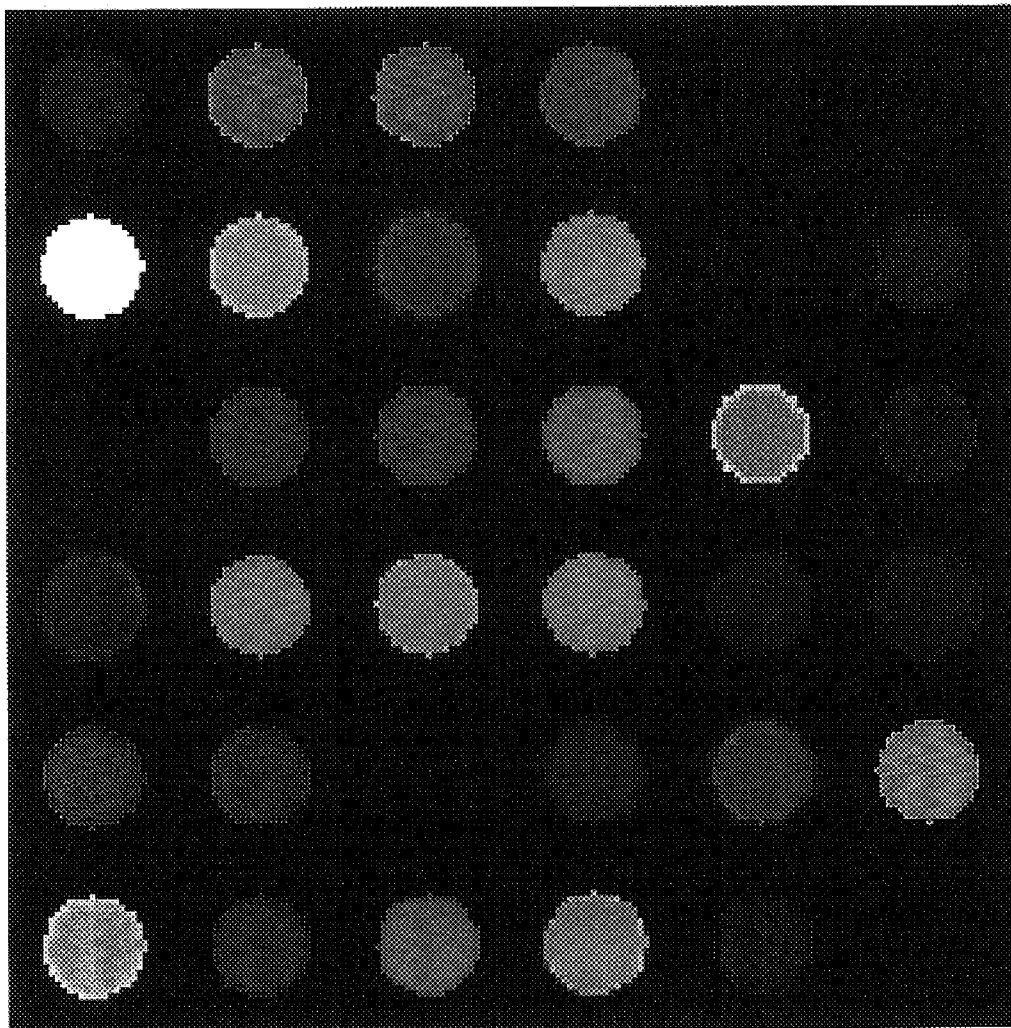

FIG. 18

FIG. 19



**COLORIMETRIC ARTIFICIAL NOSE
HAVING AN ARRAY OF DYES AND
METHOD FOR ARTIFICIAL OLFACTION**

CONTINUING APPLICATION DATA

This application is a Continuation-in-Part of U.S. application Ser. No. 09/705,329, filed on Nov. 3, 2000, now U.S. Pat. No. 6,495,102, which is a Continuation-in-Part of U.S. application Ser. No. 09/532,125, filed on Mar. 21, 2000, now U.S. Pat. No. 6,368,558.

This invention was made with Government support under Contract Nos. HL25934 awarded by the National Institutes of Health & Contract No. DAAG55-97-1-2211 awarded by the Department of the Army. The Government has certain rights in the invention.

FIELD OF THE INVENTION

The present invention relates to methods and apparatus for artificial olfaction, e.g., artificial noses, for the detection of odorants by a visual display.

BACKGROUND OF THE INVENTION

There is a great need for olfactory or vapor-selective detectors (i.e., "artificial noses") in a wide variety of applications. For example, there is a need for artificial noses that can detect low levels of odorants and/or where odorants may be harmful to humans, animals or plants. Artificial noses that can detect many different chemicals are desirable for personal dosimeters in order to detect the type and amount of odorants exposed to a human, the presence of chemical poisons or toxins, the spoilage in foods, the presence of flavorings, or the presence of vapor emitting items, such as plant materials, fruits and vegetables, e.g., at customs portals.

Conventional artificial noses have severe limitations and disadvantages and are not considered generally useful for such purposes. Limitations and disadvantages of conventional artificial noses include their need for extensive signal transduction hardware, and their inability to selectively target metal-coordinating vapors and toxins. In addition, artificial noses which incorporate mass sensitive signal transduction or polar polymers as sensor elements are susceptible to interference by water vapor. This limitation is significant in that it can cause variable response of the detector with changes ambient humidity. See F. L. Dickert, O. Hayden, Zenkel, M. E. *Anal. Chem.* 71, 1338 (1999).

Initial work in the field of artificial noses was conducted by Wilkens and Hatman in 1964, though the bulk of research done in this area has been carried out since the early 1980's. See, e.g., W. F. Wilkens, A. D. Hatman. *Ann. NY Acad. Sci.*, 116, 608 (1964); K. Pursaud, G. H. Dodd. *Nature*, 299, 352-355 (1982); and J. W. Gardner, P. N. Bartlett. *Sensors and Actuators B*, 18-19, 211-220 (1994).

Vapor-selective detectors or "artificial noses" are typically based upon the production of an interpretable signal or display upon exposure to a vapor emitting substance or odorant (hereinafter sometimes referred to as an "analyte"). More specifically, typical artificial noses are based upon selective chemical binding or an interface between a detecting compound of the artificial nose and an analyte or odorant, and then transforming that chemical binding into a signal or display, i.e., signal transduction.

Polymer arrays having a single dye have been used for artificial noses. That is, a series of chemically-diverse poly-

mers or polymer blends are chosen so that their composite response distinguishes a given odorant or analyte from others. Examples of polymer array vapor detectors, including conductive polymer and conductive polymer/carbon black composites, are discussed in: M. S. Freund, N. S. Lewis, *Proc. Natl. Acad. Sci. USA* 92, 2652-2656 (1995); B. J. Doleman, R. D. Sanner, E. J. Severin, R. H. Grubbs, N. S. Lewis, *Anal. Chem.* 70, 2560-2564 (1998); T. A. Dickinson, J. White, J. S. Kauer, D. R. Walt, *Nature* 382, 697-700 (1996)(polymer array with optical detection); A. E. Hoyt, A. J. Ricco, H. C. Yang, R. M. Crooks, *J. Am. Chem. Soc.* 117, 8672 (1995); and J. W. Grate, M. H. Abraham, *Sensors and Actuators B* 3, 85-111 (1991).

Other interface materials include functionalized self-assembled monolayers (SAM), metal oxides, and dendrimers. Signal transduction is commonly achieved with mass sensitive piezoelectric substrates, surface acoustic wave (SAW) transducers, or conductive materials. Optical transducers (based on absorbance or luminescence) have also been examined. Examples of metal oxide, SAM, and dendrimer-based detectors are discussed in J. W. Gardner, H. V. Shurmer, P. Corcoran, *Sensors and Actuators B* 4, 117-121 (1991); J. W. Gardner, H. V. Shurmer, T. T. Tan, *Sensors and Actuators B* 6, 71-75 (1992); and R. M. Crooks, A. J. Ricco, *Acc. Chem. Res.* 31, 219-227 (1998). These devices also use a single dye.

Techniques have also been developed using a metalloporphyrin for optical detection of a specific, single gas such as oxygen or ammonia, and for vapor detection by chemically interactive layers on quartz crystal microbalances. See A. E. Baron, J. D. S. Danielson, M. Gouterman, J. R. Wan, J. B. Callis, *Rev. Sci. Instrum.* 64, 3394-3402 (1993); J. Kavandi, et al., *Rev. Sci. Instrum.* 61, 3340-3347 (1990); W. Lee, et al., *J. Mater. Chem.* 3, 1031-1035 (1993); A. A. Vaughan, M. G. Baron, R. Narayanaswamy, *Anal. Comm.* 33, 393-396 (1996); J. A. J. Brunink, et al., *Anal. Chim. Acta* 325, 53-64 (1996); C. Di Natale, et al., *Sensors and Actuators B* 44, 521-526 (1997); and C. DiNatale, et al., *Mat. Sci. Eng. C* 5, 209-215 (1998). However, these techniques either require extensive signal transduction hardware, or, as noted above, are limited to the detection of a specific, single gas. They are also subject to water vapor interference problems, as discussed previously.

While typical systems to date have demonstrated some success in chemical vapor detection and differentiation, these systems have focused on the detection of non-metal binding or non-metal ligating solvent vapors, such as arenes, halocarbons and ketones. Detection of metal-ligating vapors (such as amines, thiols, and phosphines) has been much less explored. Further, while some single porphyrin based sensors have been used for detection of a single strong acid, there is a need for sensor devices that will detect a wide variety of vapors.

To summarize, there are a number of limitations and drawbacks to typical artificial noses and single porphyrin based sensors. As noted above typical artificial noses are not designed for metal binding and metal ligating vapors, such as amines, thiols, and phosphines. Further, typical artificial noses require extensive signal transduction hardware, and are subject to interference from water vapor. As noted above, single porphyrin based sensors have been used for detection of a single strong acid, but cannot detect a wide variety of vapors. Thus, there is a need for new artificial noses and methods that overcome these and other limitations of prior artificial noses and single porphyrin based sensors and methods.

SUMMARY OF THE INVENTION

The present invention comprises an array of dyes including at least a first dye and a second dye which in combination provide a spectral response distinct to an analyte or odorant. The dyes of the present invention produce a response in the spectrum range of about 200 nanometers to 2,000 nanometers, which includes the visible spectrum of light. It has now been discovered that an array of two or more dyes responds to a given ligating species with a unique color pattern spectrally and in a time dependent manner. Thus, dyes in the array of the present invention are capable of changing color in a distinct manner when exposed to any one analyte or odorant. The pattern of colors manifested by the multiple dyes is indicative of a specific or given analyte. In other words, the pattern of dye colors observed is indicative of a particular vapor or liquid species.

In a preferred embodiment, the dyes of the array are porphyrins. In another preferred embodiment, the porphyrin dyes are metalloporphyrins. In a further preferred embodiment, the array will comprise ten to fifteen distinct metalloporphyrins in combination. Metalloporphyrins are preferable dyes in the present invention because they can coordinate metal-ligating vapors through open axial coordination sites, and they produce large spectral shifts upon binding of or interaction with metal-ligating vapors. In addition, porphyrins, metalloporphyrins, and many dyes show significant color changes upon changes in the polarity of their environment; this so-called solvatochromic effect will give net color changes even in the absence of direct bonding between the vapor molecules and the metal ions. Thus, metalloporphyrins produce intense and distinctive changes in coloration upon ligand binding with metal ligating vapors.

The present invention provides a means for the detection or differentiation and quantitative measurement of a wide range of ligand vapors, such as amines, alcohols, and thiols. Further, the color data obtained using the arrays of the present innovation may be used to give a qualitative fingerprint of an analyte, or may be quantitatively analyzed to allow for automated pattern recognition and/or determination of analyte concentration. Because porphyrins also exhibit wavelength and intensity changes in their absorption bands with varying solvent polarity, weakly ligating vapors (e.g., arenes, halocarbons, or ketones) are also differentiable.

Diversity within the metalloporphyrin array may be obtained by variation of the parent porphyrin, the porphyrin metal center, or the peripheral porphyrin substituents. The parent porphyrin is also referred to as a free base ("FB") porphyrin, which has two central nitrogen atoms protonated (i.e., hydrogen cations bonded to two of the central pyrrole nitrogen atoms). A preferred parent porphyrin is depicted in FIG. 2A, with the substitution of a two hydrogen ion for the metal ion (depicted as "M") in the center of the porphyrin. In FIG. 2A, TTP stands for 5,10,15,20-tetraphenylporphyrinate(-2).

In accordance with the present invention, calorimetric difference maps can be generated by subtracting unexposed and exposed metalloporphyrin array images (obtained, for example, with a common flatbed scanner or inexpensive video or charge coupled device ("CCD") detector) with image analysis software. This eliminates the need for extensive and expensive signal transduction hardware associated with previous techniques (e.g., piezoelectric or semiconductor sensors). By simply differencing images of the array before and after exposure to analytes, the present invention

provides unique color change signatures for the analytes, for both qualitative recognition and quantitative analysis.

Sensor plates which incorporate vapor sensitive combinations of dyes comprise an embodiment of the present invention which is economical, disposable, and can be utilized to provide qualitative and/or quantitative identification of an analyte. In accordance with the present invention, a catalog of arrays and the resultant visual pattern for each analyte can be coded and placed in a look-up table or book for future reference. Thus, the present invention includes a method of detecting an analyte comprising the steps of forming an array of at least a first dye and a second dye, subjecting the array to an analyte, inspecting the first and second dyes for a spectral response, and comparing the spectral response with a catalog of analyte spectral responses to identify the analyte.

Because sensing is based upon either covalent interaction (i.e., ligation) or non-covalent solvation interactions between the analyte and the porphyrin array, a broad spectrum of chemical species is differentiable. While long response times (e.g., about 45 minutes) are observed at low analyte concentrations of about 1 ppm with reverse phase silica gel plates, use of impermeable solid supports (such as polymer- or glass-based micro-array plates) substantially increases the low-level response to less than 5 minutes.

Thus, it is an object of the present invention to provide methods and devices for artificial olfaction, vapor-selective detectors or artificial noses for a wide variety of applications. It is another object of the present invention to provide methods of detection and artificial noses that can detect low levels of odorants and/or where odorants may be harmful to living human, animal or plant cells. It is also an object of the present invention to provide methods of olfactory detection and artificial noses that can detect and quantify many different chemicals for dosimeters that can detect chemical poisons or toxins, that can detect spoilage in foods, that can detect flavorings and additives, and that can detect plant materials, e.g., fruits and vegetables.

Another object of the present invention is to provide for the detection of analytes using data analysis/pattern recognition techniques, including automated techniques.

Another object of the invention is to provide an artificial nose comprising an array, the array comprising at least a first dye and a second dye deposited directly onto a single support in a predetermined pattern combination, the combination of the dyes in the array having a distinct and direct spectral absorbance or reflectance response to an analyte wherein the first dye and the second are selected from the group of dyes consisting of chemoresponsive dyes, and the second dye is distinct from the first dye. In one embodiment, the first dye is selected from the group consisting of porphyrin, chlorin, chlorophyll, phtahlocyanine, and salen and their metal complexes. In another embodiment, the second dye is selected from the group consisting of acid-base indicator dyes and solvatochromic dyes.

Another object of the invention is to provide a method of detecting an analyte comprising the steps of: (a) forming an array of at least a first dye and a second dye deposited directly onto a single support in a predetermined pattern combination, the combination of the dyes in the array having a distinct and direct spectral absorbance or reflectance response to an analyte wherein the first dye and the second dye are selected from the group consisting of chemoresponsive dyes, and the second dye is distinct from the first dye, (b) subjecting the array to an analyte, (c) inspecting the array for a distinct and direct spectral absorbance or reflectance response, and (d) correlating the distinct and direct spectral

response to the presence of the analyte. In one embodiment, the first dye is selected from the group consisting of porphyrin, chlorin, chlorophyll, phtahlocyanine, and salen and their metal complexes. In another embodiment, the second dye is selected from the group consisting of acid-base indicator dyes and solvatochromic dyes.

Another object of the invention is to provide an artificial tongue comprising an array, the array comprising at least a first dye and a second dye deposited directly onto a single support in a predetermined pattern combination, the combination of the dyes in the array having a distinct and direct spectral absorbance or reflectance response to an analyte wherein the first dye and the second are selected from the group of dyes consisting of chemoresponsive dyes, and the second dye is distinct from the first dye. In one embodiment, the first dye is selected from the group consisting of porphyrin, chlorin, chlorophyll, phtahlocyanine, and salen and their metal complexes. In another embodiment, the second dye is selected from the group consisting of acid-base indicator dyes and solvatochromic dyes.

BRIEF DESCRIPTION OF THE DRAWINGS

The file of this patent contains at least one drawing executed in color. Copies of this patent with color drawing(s) will be provided by the Patent and Trademark Office upon request and payment of the necessary fee.

FIG. 1 illustrates an embodiment of the necessary sensing plate of the present invention using a first elution in the y axis and a second elution in the x axis of the plate. In this embodiment the first elution R—OH/hexane and the second elution is R—SH/hexane.

FIG. 2A illustrates an embodiment of the invention using metalloporphyrins as the sensing dyes.

FIG. 2B illustrates an embodiment of the invention using metalloporphyrins as the sensing dyes.

FIG. 3A illustrates a vapor exposure apparatus for demonstration of the present invention.

FIG. 3B illustrates a vapor exposure apparatus for demonstration of the present invention.

FIG. 4 illustrates the color change profile in a metalloporphyrin array of FIG. 2 when used in the vapor exposure apparatus of FIG. 3A to detect n-butylamine. Metalloporphyrins were immobilized on reverse phase silica gel plates.

FIG. 5 illustrates a comparison of color changes at saturation for a wide range of analytes. Each analyte was delivered to the array as a nitrogen stream saturated with the analyte vapor at 20° C. DMF stands for dimethylformamide; THF stands for tetrahydrofuran.

FIG. 6 illustrates two component saturation responses of mixtures of 2-methylpyridine and trimethylphosphite. Vapor mixtures were obtained by mixing two analyte-saturated N₂ streams at variable flow ratios.

FIG. 7 illustrates a comparison of Zn(TPP) spectral shifts upon exposure to ethanol and pyridine (py) in methylene chloride solution (A) and on the reverse phase support (B).

FIG. 8 illustrates another embodiment of the present invention, and more particularly, an small array comprising microwells built into a wearable detector which also contains a portable light source and a light detector, such as a charge-coupled device (CCD) or photodiode array.

FIG. 9 illustrates another embodiment of the present invention, and more particularly, a microwell porphyrin array wellplate constructed from polydimethylsiloxane (PDMS).

FIG. 10 illustrates another embodiment of the present invention, and more particularly, a microplate containing

machined teflon posts, upon which the porphyrin array is immobilized in a polymer matrix (polystyrene/dibutylphthalate).

FIG. 11 illustrates another embodiment of the present invention, showing a microplate of the type shown in FIG. 10, consisting of a minimized array of four metalloporphyrins, showing the color profile changes for n-octylamine, dodecanethiol, and tri-n-butylphosphine, each at 1.8 ppm.

FIG. 12 illustrates the immunity of the present invention to interference from water vapor.

FIG. 13 illustrates the synthesis of siloxyl-substituted bis-pocket porphyrins in accordance with the present invention.

FIGS. 14a, 14b, and 14c illustrate differences in K_{eq} for various porphyrins.

FIG. 15 illustrates molecular models of Zn(Si₆PP) (left column) and Zn(Si₈PP) (right column).

FIG. 16 illustrates an array containing illustrative examples of porphyrin, metalloporphyrin, acid-base indicator, and solvatochromic dyes.

FIG. 17 illustrates the response of the array described in FIG. 16 to acid vapors, specifically formic acid, acetic acid, iso-valeric acid, and 3-methyl-2-hexenoic acid.

FIG. 18 illustrates a preferred array containing illustrative examples of porphyrin, metalloporphyrin, acid-base indicator, and solvatochromic dyes.

FIG. 19 illustrates the response of the array described in FIG. 18 to acetone.

DETAILED DESCRIPTION OF THE PREFERRED EMBODIMENTS

Production of the Sensor Plate of the Present Invention

A sensor plate 10 fabricated in accordance with the present invention is shown in FIG. 1. Sensor plate 10 comprises a two-dimensionally spatially resolved array 12 of various sensing elements or dyes 14 capable of changing color upon interaction (e.g., binding, pi-pi complexation, or polarity induced shifts in color). As shown in FIG. 1, a library of such dyes 14 can be given spatial resolution by two-dimensional chromatography or by direct deposition, including, but not limited to, ink-jet printing, micropipette spotting, screen printing, or stamping. In FIG. 1, metalloporphyrin mixture 6 is placed at origin 7. Next, the metalloporphyrin mixture 6 is eluted through a silica gel or reversed-phase silica gel 5 in sensor plate 10, and the metalloporphyrins are spatially resolved from each other and immobilized in silica gel 5 as depicted by the oval and circular shapes 4 as shown in FIG. 1. Sensor plate 10 can be made from any suitable material or materials, including but not limited to, chromatography plates, paper, filter papers, porous membranes, or properly machined polymers, glasses, or metals.

FIG. 1 also illustrates an embodiment of the optical sensing plate of the present invention using a first elution 8 in the y axis and a second elution 9 in the x axis of sensor plate 10. In this embodiment, the first elution 8 is R—OH/hexane and the second elution 9 is R—SH/hexane. The order of the first and second elutions can be reversed. The first and second elutions are used to spatially resolve the metalloporphyrin mixture 6 in silica gel 5. As shown in FIG. 1, the upper left hand quadrant 3 is characterized by metalloporphyrins that are "hard" selective, i.e., having a metal center having a high chemical hardness, i.e., a high charge density. As shown in FIG. 1, the lower right hand quadrant 2 is characterized by metalloporphyrins that are "soft" selective,

i.e., having a metal center having a low chemical hardness, i.e., a low charge density. In accordance with the present invention, the array can be a spatially resolved collection of dyes, and more particularly a spatially resolved combinatorial family of dyes.

In accordance with the present invention, a porphyrin—metalloporphyrin sensor plate was prepared and then used to detect various odorants. More specifically, solutions of various metalated tetraphenylporphyrins in either methylene chloride or chlorobenzene were spotted in 1 μ L aliquots onto two carbon (“C2”, i.e., ethyl-capped) reverse phase silica thin layer chromatography plates (Product No. 4809-800, by Whatman, Inc., Clifton, N.J.) to yield the sensor array **16** seen in FIG. 2B. As shown in FIG. 2B and summarized in Table 1 below, the dyes have the following colors (the exact colors depend, among other things, upon scanner settings).

TABLE 1

(Summarizing Colors of Dyes in FIG. 2B)		
Sn ⁴⁺ - Green	Co ³⁺ - Red	Cr ³⁺ - Deep Green
Mn ³⁺ - Green	Fe ³⁺ - Dark Red	Co ²⁺ - Red
Cu ²⁺ - Red	Ru ²⁺ - Light Yellow	Zn ²⁺ - Greenish Red
Ag ²⁺ - Red	2H ⁺ (Free Base “FB”) - Red	

A metalloporphyrin **15**, sometimes referred to as M(TPP), of the present invention is depicted in FIG. 2A. FIG. 2A also depicts various metals of the metalloporphyrins **15** of the present invention, and corresponding metal ion charge to radius ratio (i.e., Z/r Ratio) in reciprocal angstroms. The Z/r Ratio should preferably span a wide range in order to target a wide range of metal ligating analytes. These metalloporphyrins have excellent chemical stability on the solid support and most have well-studied solution ligation chemistry. Reverse phase silica was chosen as a non-interacting dispersion medium for the metalloporphyrin array **16** depicted in FIG. 2B, as well as a suitable surface for diffuse reflectance spectral measurements. More importantly, the reverse phase silica presents a hydrophobic interface, which virtually eliminates interference from ambient water vapor. After spotting, sensor plates **18** like the one depicted in FIG. 2B were dried under vacuum at 50° C. for 1 hour prior to use. Thus, immobilization of the metalloporphyrins on a reverse phase silica support is obtained. While ten (10) different metalloporphyrins are shown in FIG. 2A, those of skill in the art will recognize that many other metalloporphyrins are useful in accordance with the present invention. Those of skill in the art will further recognize that in accordance with the broad teachings of the present invention, any dyes capable of changing color upon interacting with an analyte, both containing and not containing metal ions, are useful in the array of the present invention.

Colorimetric Analysis Using the Sensor Plate

For the detection and analysis of odorants in accordance with the present invention, one needs to monitor the absorbance of the sensor plate at one or more wavelengths in a spatially resolved fashion. This can be accomplished with an imaging spectrophotometer, a simple flatbed scanner (e.g. a Hewlett Packard Scanjet 3c), or an inexpensive video or CCD camera.

FIG. 3A illustrates a vapor exposure apparatus **19** of the present invention. FIG. 3B illustrates top and side views of bottom piece **21** and a top view of top piece **21'** of a vapor exposure flow cell **20** of the present invention. In an embodiment of the present invention for purposes of demonstration,

each sensor plate **18** was placed inside of a stainless steel flow cell **20** equipped with a quartz window **22** as shown in FIGS. 3A and 3B. Scanning of the sensor plate **18** was done on a commercially available flatbed scanner **24** (Hewlett Packard Scanjet 3c) at 200 dpi resolution, in full color mode. Following an initial scan, a control run with a first pure nitrogen flow stream **26** was performed. The array **16** of plate **18** was then exposed to a second nitrogen flow stream **28** saturated with a liquid analyte **30** of interest. As shown in FIG. 3A, the nitrogen flow stream **28** saturated with liquid analyte **30** results in a saturated vapor **32**. Saturated vapor **32**, containing the analyte **30** of interest were generated by flowing nitrogen flow stream **28** at 0.47 L/min. through the neat liquid analyte **30** in a water-jacketed, glass fritted bubbler **34**. Vapor pressures were controlled by regulating the bubbler **34** temperature. As shown in FIG. 3B, vapor channels **23** permit vapor flow to sensor plate **18**.

EXAMPLE 1

Scanning at different time intervals and subtracting the red, green and blue (“RGB”) values of the new images from those of the original scan yields a color change profile. This is shown for n-butylamine in FIG. 4, in which color change profiles of the metalloporphyrin sensor array **16** as a function of exposure time to n-butylamine vapor. Subtraction of the initial scan from a scan after 5 min. of N₂ exposure was used as a control, giving a black response, as shown. 9.3% n-butylamine in N₂ was then passed over the array and scans made after exposure for 30 s, 5 min., and 15 min. The red, green and blue (“RGB”) mode images were subtracted (absolute value) to produce the color change profiles illustrated. Virtually all porphyrins are saturated after 30 seconds of exposure, yielding a color fingerprint unique for each class of analytes, which is illustrated in FIG. 4.

More specifically, subtraction of the initial scan **40** from a scan after 5 min. of N₂ exposure was used as a control, giving a black response, as shown in FIG. 4. A nitrogen flow stream containing 0.093% n-butylamine was then passed over the array **16** and scans **42**, **44**, and **46** were made after exposure for 30 seconds, 5 minutes, and 15 minutes, respectively. The RGB mode images were subtracted (absolute value) using Adobe Photoshop™ (which comprises standard image analyzing software), with contrast enhancement by expanding the pixel range (a 32 value range was expanded to 256 each for the R, G, and B values). Subtraction of exposed and unexposed images gives color change patterns that vary in hue and intensity. Because differentiation is provided by an array of detectors, the system has parallels the mammalian olfactory system. As shown in FIG. 4 and summarized in Table 2 below, the dyes have the following colors in scans **42**, **44**, and **46**.

TABLE 2

(Summarizing Colors of Dyes in FIG. 4, Scans 42, 44, and 46)		
Sn ⁴⁺ - No Change	Co ³⁺ - Green	Cr ³⁺ - Green
Mn ³⁺ - No Change	Fe ³⁺ - Red	Co ²⁺ - Faint Green
Cu ²⁺ - No Change	Ru ²⁺ - No Change	Zn ²⁺ - Light Green
Ag ²⁺ - No Change	2H ⁺ (Free Base “FB”) — Light Blue	

As summarized in Table 3 below, for the TTP array **16** depicted on the left-hand side of FIG. 4, the dyes have the following colors.

TABLE 3

Sn ⁴⁺ - Greenish Yellow	Co ³⁺ - Red	Cr ³⁺ - Yellow with Dark Red Center
Mn ³⁺ - Greenish Yellow	Fe ³⁺ - Dark Red	Co ²⁺ - Red
Cu ²⁺ - Red	Ru ²⁺ - Light Yellow	Zn ²⁺ - Red
Ag ²⁺ - Red	2H ⁺ (Free Base "FB") - Red	

EXAMPLE 2

Visible spectral shifts and absorption intensity differences occur upon ligation of the metal center, leading to readily observable color changes. As is well known to those with skill in the art, the magnitude of spectral shift correlates with the polarizability of the ligand; hence, there exists an electronic basis for analyte distinction. Using metal centers that span a range of chemical hardness and ligand binding affinity, a wide range of volatile analytes (including soft ligands, such as thiols, and harder ligands, such as amines) are differentiable. Because porphyrins have been shown to exhibit wavelength and intensity changes in their absorption

bands with varying solvent polarity, it is contemplated that the methods and apparatus of the present invention can be used to calorimetrically distinguish among a series of weakly ligating solvent vapors (e.g., arenes, halocarbons, or ketones), as shown for example in FIG. 5.

A comparison of color changes at saturation for a wide range of analytes is shown in FIG. 5. Each analyte is identified under the colored array 16 that identifies each analyte. DMF stands for the analyte dimethylformamide, and THF stands for the analyte tetrahydrofuran. As shown in FIG. 5 and summarized in Table 4 below, the colors of each dye in response to a particular analyte are as follows.

TABLE 4

Analyte: DMF		
Sn ⁴⁺ - No Change	Co ³⁺ - Green	Cr ³⁺ - No Change
Mn ³⁺ - No Change	Fe ³⁺ - No Change	Co ²⁺ - No Change
Cu ²⁺ - Blue	Ru ²⁺ - No Change	Zn ²⁺ - No Change
Ag ²⁺ - No Change	2H ⁺ (Free Base "FB") - Blue	
Analyte: Ethanol		
Sn ⁴⁺ - Dark Blue	Co ³⁺ - No Change	Cr ³⁺ - Red
Mn ³⁺ - No Change	Fe ³⁺ - No Change	Co ²⁺ - No Change
Cu ²⁺ - No Change	Ru ²⁺ - No Change	Zn ²⁺ - Blue
Ag ²⁺ - No Change	2H ⁺ (Free Base "FB") - No Change	
Analyte: Pyridine		
Sn ⁴⁺ - No Change	Co ³⁺ - Green	Cr ³⁺ - Dark Green
Mn ³⁺ - No Change	Fe ³⁺ - No Change	Co ²⁺ - No Change
Cu ²⁺ - No Change	Ru ²⁺ - No Change	Zn ²⁺ - Green
Ag ²⁺ - No Change	2H ⁺ (Free Base "FB") - Blue	
Analyte: Hexylamine		
Sn ⁴⁺ - No Change	Co ³⁺ - Dark Green	Cr ³⁺ - Green
Mn ³⁺ - No Change	Fe ³⁺ - Red	Co ²⁺ - No Change
Cu ²⁺ - Blue	Ru ²⁺ - No Change	Zn ²⁺ - Green
Ag ²⁺ - Dark Blue	2H ⁺ (Free Base "FB") - Blue	
Analyte: Acetonitrile		
Sn ⁴⁺ - Blue	Co ³⁺ - Dark Green	Cr ³⁺ - No Change
Mn ³⁺ - Yellow	Fe ³⁺ - Dark Green	Co ²⁺ - No Change
Cu ²⁺ - Blue	Ru ²⁺ - Blue (faint dot)	Zn ²⁺ - Blue
Ag ²⁺ - No Change	2H ⁺ (Free Base "FB") - Blue	
Analyte: Acetone		
Sn ⁴⁺ - No Change	Co ³⁺ - No Change	Cr ³⁺ - Red (small dot)
Mn ³⁺ - No Change	Fe ³⁺ - No Change	Co ²⁺ - No Change
Cu ²⁺ - Dark Blue	Ru ²⁺ - No Change	Zn ²⁺ - Dark Blue
Ag ²⁺ - No Change	2H ⁺ (Free Base "FB") - Blue	
Analyte: THF		
Sn ⁴⁺ - Dark Blue	Co ³⁺ - Green	Cr ³⁺ - Red
Mn ³⁺ - Blue (small dot)	Fe ³⁺ - Dark Green	Co ²⁺ - No Change
Cu ²⁺ - Blue	Ru ²⁺ - No Change	Zn ²⁺ - Blue
Ag ²⁺ - No Change	2H ⁺ (Free Base "FB") - Blue	
Analyte: CH ₂ Cl ₂		
Sn ⁴⁺ - Dark Blue	Co ³⁺ - No Change	Cr ³⁺ - No Change
Mn ³⁺ - Yellow and Red (small dot)	Fe ³⁺ - No Change	Co ²⁺ - No Change
Cu ²⁺ - Dark Blue	Ru ²⁺ - No Change	Zn ²⁺ - No Change
Ag ²⁺ - No Change	2H ⁺ (Free Base "FB") - Blue	

TABLE 4-continued

Analyte: CHCl_3		
Sn ⁴⁺ - Dark Blue	Co ³⁺ - Dark Green	Cr ³⁺ - Yellow (circle)
Mn ³⁺ - Yellow	Fe ³⁺ - Dark Green (very faint)	Co ²⁺ - No Change
Cu ²⁺ - Dark Blue (very faint)	Ru ²⁺ - No Change	Zn ²⁺ - Blue
Ag ²⁺ - Blue (very faint)	2H ⁺ (Free Base "FB") - Blue	
Analyte: $\text{P}(\text{OC}_2\text{H}_5)_3$		
Sn ⁴⁺ - No Change	Co ³⁺ - Yellow	Cr ³⁺ - Dark Green
Mn ³⁺ - No Change	Fe ³⁺ - Dark Green (very faint)	Co ²⁺ - Greenish Yellow
Cu ²⁺ - Dark Blue (faint)	Ru ²⁺ - No Change	Zn ²⁺ - Greenish Blue
Ag ²⁺ - Blue (very faint)	2H ⁺ (Free Base "FB") - Blue	
Analyte: $\text{P}(\text{C}_4\text{H}_9)_3$		
Sn ⁴⁺ - No Change	Co ³⁺ - Yellow and Red	Cr ³⁺ - Deep Red
Mn ³⁺ - No Change	Fe ³⁺ - Dark Green (faint)	Co ²⁺ - Red (with some yellow)
Cu ²⁺ - No Change	Ru ²⁺ - Dark Blue	Zn ²⁺ - Yellow
Ag ²⁺ - No Change	2H ⁺ (Free Base "FB") - No Change	
Analyte: $\text{C}_6\text{H}_{13}\text{SH}$		
Sn ⁴⁺ - Green	Co ³⁺ - No Change	Cr ³⁺ - Yellow circle surrounded by greenish blue circle
Mn ³⁺ - Yellow	Fe ³⁺ - Dark Green	Co ²⁺ - No Change
Cu ²⁺ - Dark Blue (faint)	Ru ²⁺ - No Change	Zn ²⁺ - Green
Ag ²⁺ - Blue (very faint)	2H ⁺ (Free Base "FB") - Blue	
Analyte: $(\text{C}_3\text{H}_7)_2\text{S}$		
Sn ⁴⁺ - Dark Blue (faint)	Co ³⁺ - Deep Green	Cr ³⁺ - Green
Mn ³⁺ - No Change	Fe ³⁺ - Dark Green	Co ²⁺ - Dark Green (very faint)
Cu ²⁺ - Dark Blue (faint)	Ru ²⁺ - Green	Zn ²⁺ - Green
Ag ²⁺ - Blue (very faint)	2H ⁺ (Free Base "FB") - Blue	
Analyte: Benzene		
Sn ⁴⁺ - No Change	Co ³⁺ - Green	Cr ³⁺ - Yellow (very faint)
Mn ³⁺ - Yellow (some green)	Fe ³⁺ - Dark Green	Co ²⁺ - No Change
Cu ²⁺ - No Change	Ru ²⁺ - No Change	Zn ²⁺ - Dark Green
Ag ²⁺ - No Change	2H ⁺ (Free Base "FB") - Blue	

The degree of ligand softness (roughly their polarizability) increases from left to right, top to bottom as shown in FIG. 1. Each analyte is easily distinguished from the others, and there are family resemblances among chemically similar species (e.g., pyridine and n-hexylamine). Analyte distinction originates both in the metal-specific ligation affinities and in their specific, unique color changes upon ligation. Each analyte was delivered to the array as a nitrogen stream saturated with the analyte vapor at 20° C. (to ensure complete saturation, 30 min. exposures to vapor were used. Although these fingerprints were obtained by exposure to saturated vapors (thousands of ppm), unique patterns can be identified at much lower concentrations.

The metalloporphyrin array **16** has been used to quantify single analytes and to identify vapor mixtures. Because the images' color channel data (i.e., RGB values) vary linearly with porphyrin concentration, we were able to quantify single porphyrin responses to different analytes. Color channel data were collected for individual spots and plotted, for example, as the quantity $(R_{pl} - R_{spt}) / (R_{pl})$, where R_{pl} was the red channel value for the initial silica surface and R_{spt} the average value for the spot. For example, Fe(TFPP)(Cl) responded linearly to octylamine between 0 and 1.5 ppm. Other porphyrins showed linear response ranges that varied with ligand affinity (i.e., equilibrium constant).

40

EXAMPLE 3

The array of the present invention has demonstrated interpretable and reversible responses even to analyte mixtures of strong ligands, such as pyridines and phosphites, as is shown in FIG. 6. Color change patterns for the mixtures are distinct from either of the neat vapors. Good reversibility was demonstrated for this analyte pair as the vapor mixtures were cycled between the neat analyte extremes, as shown in FIG. 6, which shows the two component saturation responses to mixtures of 2-methylpyridine ("2MEPY") and trimethylphosphite ("TMP"). Vapor mixtures were obtained by mixing the analyte-saturated N₂ streams at variable flow ratios. A single plate was first exposed to pure trimethylphosphite vapor in N₂ (Scan A), followed by increasing mole fractions of 2-methylpyridine up to pure 2-methylpyridine vapor (Scan C), followed by decreasing mole fractions of 2-methylpyridine back to pure trimethylphosphite vapor. In both directions, scans were taken at the same mole fraction trimethylphosphite and showed excellent reversibility; scans at mole fractions at 67% trimethylphosphite ($\chi_{tmp} = 0.67$, Scans B and D) and of their difference map are shown (Scan E). Response curves for the individual porphyrins allow for quantification of the mixture composition. The colors of each dye upon exposure to the analytes TMP and 2MEPY are shown in FIG. 6 and are summarized in Table 5 below.

45

50

55

60

65

TABLE 5

Scan A, Analyte: Neat TMP		
Sn ⁴⁺ - Dark Blue	Co ³⁺ - Yellow	Cr ³⁺ - No Change
Mn ³⁺ - Yellow with red center	Fe ³⁺ - Dark Green	Co ²⁺ - Greenish Yellow
Cu ²⁺ - Dark Blue	Ru ²⁺ - No Change	Zn ²⁺ - Blue
Ag ²⁺ - Green (very faint)	2H ⁺ (Free Base "FB") — Reddish Blue	
Scan B, Analyte: TMP, x _{TMP} = 0.67		
Sn ⁴⁺ - Blue	Co ³⁺ - Green	Cr ³⁺ - Green (small dot)
Mn ³⁺ - Yellow and Green	Fe ³⁺ - Green and Yellow	Co ²⁺ - Green with red center
Cu ²⁺ - Dark Blue	Ru ²⁺ - Purple (very faint)	Zn ²⁺ - Blue
Ag ²⁺ - Greenish Blue	2H ⁺ (Free Base "FB") — Reddish Blue	
Scan C, Analyte: Neat 2MEPY		
Sn ⁴⁺ - Blue	Co ³⁺ - Green	Cr ³⁺ - No Change
Mn ³⁺ - Yellow and Green with Red center	Fe ³⁺ - Red with some Yellow	Co ²⁺ - Green
Cu ²⁺ - Dark Blue	Ru ²⁺ - Deep Blue	Zn ²⁺ - Green with some Blue
Ag ²⁺ - Green with some Blue	2H ⁺ (Free Base "FB") — Reddish Blue	
Scan D, Analyte: TMP, x _{TMP} = 0.67		
Sn ⁴⁺ - Blue	Co ³⁺ - Green	Cr ³⁺ - No Change
Mn ³⁺ - Yellow and Green	Fe ³⁺ - Green and Yellow	Co ²⁺ - Green
Cu ²⁺ - Dark Blue	Ru ²⁺ - Purple (very faint)	Zn ²⁺ - Blue
Ag ²⁺ - Greenish Blue (very faint)	2H ⁺ (Free Base "FB") — Reddish Blue	
Scan E		
Sn ⁴⁺ - No Change	Co ³⁺ - No Change	Cr ³⁺ - No Change
Mn ³⁺ - No Change	Fe ³⁺ - No Change	Co ²⁺ - No Change
Cu ²⁺ - Blue (very faint)	Ru ²⁺ - Blue (small dot)	Zn ²⁺ - No Change
Ag ²⁺ - Blue (very faint)	2H ⁺ (Free Base "FB") - Green	

EXAMPLE 4

In an effort to understand the origin of the color changes upon vapor exposure, diffuse reflectance spectra were obtained for single porphyrin spots before and after exposure to analyte vapors. Porphyrin solutions were spotted in 50 μ L aliquots onto a plate and allowed to dry under vacuum at 50° C. Diffuse reflectance spectra of the plate were then taken using a UV-visible spectrophotometer equipped with an integrating sphere. Unique spectral shifts were observed upon analyte exposure, which correlated well with those seen from solution ligation. For example, Zn(TPP) exposure to ethanol and pyridine gave unique shifts which were very similar to those resulting from ligand exposure in solution. FIG. 7 shows a comparison of Zn(TPP) spectral shifts upon exposure to ethanol and pyridine (py) in methylene chloride solution (A) and on the reverse phase support (B). In both A and B, the bands correspond, from left to right, to Zn(TPP), Zn(TPP)(C₂H₅OH), and Zn(TPP)(py), respectively. Solution spectra (A) were collected using a Hitachi U-3300 spectrophotometer; Zn(TPP), C₂H₅OH, and py concentrations were approximately 2 μ M, 170 mM, and 200 μ M, respectively. Diffuse reflectance spectra (B) were obtained with an integrating sphere attachment before exposure to analytes, after exposure to ethanol vapor in N₂, and after exposure to pyridine vapor in N₂ for 30 min. each using the flow cell.

Improvement to Low Concentration Response

Color changes at levels as low as 460 ppb have been observed for octylamine vapor, albeit with slow response times due to the high surface area of the silica on the plate 18. The surface area of C2 plates is \approx 350 m²/gram. Removal of excess silica gel surrounding the porphyrin spots from the

plate 18 led to substantial improvements in response time for exposures to trace levels of octylamine. Because the high surface area of the reverse phase silica surface is primarily responsible for the increased response time, other means of solid support or film formation can be used to improve low concentration response.

Further, the present invention contemplates miniaturization of the array using small wells 60 (<1 mm), for example in glass, quartz, or polymers, to hold metalloporphyrin or other dyes as thin films, which are deposited as a solution, by liquid droplet dispersion (e.g., airbrush or inkjet), or deposited as a solution of polymer with metalloporphyrin.

These embodiments are depicted in FIGS. 8, 9, and 10. FIG. 8 illustrates the interfacing of a microplate 60 into an assembly consisting of a CCD 70, a microplate 72 and a light source 74. FIG. 9 illustrates another embodiment of the present invention, and more particularly, a microwell porphyrin array wellplate 80 constructed from polydimethylsiloxane (PDMS). The colors of the dyes shown in FIG. 9 are summarized below in Table 6.

TABLE 6

Sn ⁴⁺ - Dark Red	Co ³⁺ - Dark Red	Cr ³⁺ - Dark Green
Mn ³⁺ - Green	Fe ³⁺ - Dark Red	Co ²⁺ - Yellowish Green
Cu ²⁺ - Deep Red	Ru ²⁺ - Dark Red	Zn ²⁺ - Red with some Yellow
Ag ²⁺ - Red	2H ⁺ (Free Base "FB") — Red	

FIG. 10 demonstrates deposition of metalloporphyrin/polymer (polystyrene/dibutylphthalate) solutions upon a plate, which includes a series of micro-machined Teflon® posts 100 having the same basic position relative to each

15

other as shown in FIG. 2A and FIG. 2B. The colors for the dyes in the middle of FIG. 10 are summarized in Table 7 below.

TABLE 7

Sn ⁴⁺ - Yellow	Co ³⁺ - Orange	Cr ³⁺ - Yellow
Mn ³⁺ - Yellow	Fe ³⁺ - Orange	Co ²⁺ - Orange
Cu ²⁺ - Orange	Ru ²⁺ - Dark Yellow	Zn ²⁺ - Orange
Ag ²⁺ - Orange	2H ⁺ (Free Base "FB") - Red	

The colors for the dyes on the right hand side of FIG. 10 are summarized in Table 8 below.

TABLE 8

Sn ⁴⁺ - No Change	Co ³⁺ - Green	Cr ³⁺ - Red
Mn ³⁺ - Blue	Fe ³⁺ - Red	Co ²⁺ - Red, Green, Blue, and Yellow
Cu ²⁺ - Green with some Blue	Ru ²⁺ - Blue (very faint)	Zn ²⁺ - Yellow with some Red
Ag ²⁺ - Green with some Blue	2H ⁺ (Free Base "FB") - Green with some Blue	

EXAMPLE 5

FIG. 11 shows the color profile changes from a microplate of the type shown in FIG. 10. The microplate, consisting of a minimized array of four metalloporphyrins, i.e., Sn(TPP)(Cl₂), Co(TPP)(Cl), Zn(TPP), Fe(TFPP)(Cl), clockwise from the upper left (where TFPP stands for 5,10,15,20-tetrakis(pentafluorophenyl)porphyrinate). The color profile changes are shown in FIG. 11 after exposure to low levels of n-octylamine, dodecanethiol (C₁₂H₂₅SH), and tri-n-butylphosphine (P(C₄H₉)₃), each at 1.8 ppm, which is summarized in Table 9 below.

TABLE 9

Dyes on Teflon®	
Sn - Dark Yellow	Co - Red
Zn - Red	Fe - Orange with Red outline
Dyes exposed to n-octylamine	
Sn - No Change	Co - Green (very faint)
Zn - Red	Fe - Green
Dyes exposed to C ₁₂ H ₂₅ SH	
Sn - Red	Co - Green with some red, yellow and blue (faint)
Zn - Red with some green and yellow	Fe - Blue (very faint)
Dyes exposed to P(C ₄ H ₉) ₃	
Sn - No Change	Co - Yellow with red center and some red periphery
Zn - Green	Fe - Yellow with some Green and Blue

16

The low ppm levels of octylamine, an analyte of interest, were generated from temperature-regulated octylamine/dodecane solutions with the assumption of solution ideality. The dodecane acts as a diluent to lower the level of octylamine vapor pressure for the purposes of this demonstration of the invention.

EXAMPLE 6

FIG. 12 illustrates the immunity of the present invention to interference from water vapor. The hydrophobicity of the

reverse phase support greatly any possible effects from varying water vapor in the atmosphere to be tested. For instance, as shown in FIG. 12, a color fingerprint generated from exposure of the array to n-hexylamine (0.86% in N₂) was identical to that for n-hexylamine spiked heavily with water vapor (1.2% H₂O, 0.48% hexylamine in N₂). See scans 120, 122 and 124. The ability to easily detect species in the presence of a large water background represents a substantial advantage over mass-sensitive sensing techniques or methodologies that employ polar polymers as part of the sensor array. The color patterns shown in FIG. 12 are summarized in Table 10 below.

TABLE 10

Scan 120		
Sn ⁴⁺ - No Change	Co ³⁺ - Green	Cr ³⁺ - Green
Mn ³⁺ - No Change	Fe ³⁺ - Red	Co ²⁺ - No Change
Cu ²⁺ - No Change	Ru ²⁺ - No Change	Zn ²⁺ - Green
Ag ²⁺ - No Change	2H ⁺ (Free Base "FB") - Dark Blue	
Scan 122		
Sn ⁴⁺ - No Change	Co ³⁺ - Green	Cr ³⁺ - Green
Mn ³⁺ - No Change	Fe ³⁺ - Red	Co ²⁺ - No Change
Cu ²⁺ - No Change	Ru ²⁺ - Green (small dot)	Zn ²⁺ - Green
Ag ²⁺ - No Change	2H ⁺ (Free Base "FB") - Dark Blue	
Scan 124		
Sn ⁴⁺ - Bluish Circle	Co ³⁺ - Bluish Circle	Cr ³⁺ - Bluish Circle
Mn ³⁺ - Bluish Circle	Fe ³⁺ - Bluish Circle	Co ²⁺ - Bluish Circle
Cu ²⁺ - Bluish Circle	Ru ²⁺ - Bluish Circle	Zn ²⁺ - Bluish Circle
Ag ²⁺ - Bluish Circle	2H ⁺ (Free Base "FB") - Bluish Circle	

Additional Features of the Preferred Embodiments of the Invention

Having demonstrated electronic differentiation, an important further goal is the shape-selective distinction of analytes (e.g., n-hexylamine vs. cyclohexylamine). Functionalized metalloporphyrins that limit steric access to the metal ion are candidates for such differentiation. For instance, we have been able to control ligation of various nitrogenous ligands to dendrimer-metalloporphyrins and induce selectivities over a range of more than 10⁴. As an initial attempt toward shape-selective detection, we employed the slightly-hindered tetrakis(2,4,6-trimethoxyphenyl)porphyrins (TTMPP) in our sensing array. With these porphyrins, fingerprints for t-butylamine and n-butylamine showed subtle distinctions, as did those for cyclohexylamine and n-hexylamine. Using more hindered metalloporphyrins, it is contemplated that the present invention can provide greater visual differentiation. Such porphyrins include those whose periphery is decorated with dendrimer, siloxyl, phenyl, t-butyl and other bulky substituents, providing sterically constrained pockets on at least one face (and preferably both) of the porphyrin.

In a similar fashion, it is contemplated that the sensor plates of the present invention can be used for the detection of analytes in liquids or solutions, or solids. A device that detects an analyte in a liquid or solution or solid can be referred to as an artificial tongue. Proper choice of the metal complexes and the solid support must preclude their dissolution into the solution to be analyzed. It is preferred that the surface support repel any carrier solvent to promote the detection of trace analytes in solution; for example, for analysis of aqueous solutions, reverse phase silica has advantages as a support since it will not be wetted directly by water.

Alternative sensors in accordance with the present invention may include any other dyes or metal complexes with intense absorbance in the ultraviolet, visible, or near infrared spectra that show a color change upon exposure to analytes. These alternative sensors include, but are not limited to, a variety of macrocycles and non-macrocycles such as chlorins and chlorophylls, phthalocyanines and metallophthalocyanines, salen-type compounds and their metal complexes, or other metal-containing dyes.

The present invention can be used to detect a wide variety of analytes regardless of physical form of the analytes. That is, the present invention can be used to detect any vapor

emitting substance, including liquid, solid, or gaseous forms, and even when mixed with other vapor emitting substances, such solution mixtures of substances.

25 The present invention can be used in combinatorial libraries of metalloporphyrins for shape selective detection of substrates where the substituents on the periphery of the macrocycle or the metal bound by the porphyrin are created and then physically dispersed in two dimensions by (partial) chromatographic or electrophoretic separation.

30 The present invention can be used with chiral substituents on the periphery of the macrocycle for identification of chiral substrates, including but not limited to drugs, natural products, blood or bodily fluid components.

35 The present invention can be used for analysis of biological entities based on the surface proteins, oligosaccharides, antigens, etc., that interact with the metalloporphyrin array sensors of the present invention. Further, the sensors of the present invention can be used for specific recognition of individual species of bacteria or viruses.

40 The present invention can be used for analysis of nucleic acid sequences based on sequence specific the surface interactions with the metalloporphyrin array sensors. The sensors of the present invention can be used for specific recognition of individual sequences of nucleic acids. Substituents on the porphyrins that would be particularly useful in this regard are known DNA intercalating molecules and nucleic acid oligomers.

45 The present invention can be used with ordinary flat bed scanners, as well as portable miniaturized detectors, such as CCD detectors with microarrays of dyes such as metalloporphyrins.

50 The present invention can be used for improved sensitivity, automation of pattern recognition of liquids and solutions, and analysis of biological and biochemical samples.

Superstructure Bonded to the Periphery of the Porphyrin

55 The present invention includes modified porphyrins that have a super structure bonded to the periphery of the porphyrin. A super structure bonded to the periphery of the porphyrin in accordance with the present invention includes any additional structural element or chemical structure built at the edge of the porphyrin and bonded thereto.

60 The super structures can include any structural element or chemical structure characterized in having a certain selectivity. Those of skill in the art will recognize that the super structures of the present invention include structures that are

shape selective, polarity selective, inantio selective, regio selective, hydrogen bonding selective, and acid-base selective. These structures can include siloxyl-substituted substituents, nonsiloxyl-substituted substituents and nonsiloxyl-substituted substituents, including but not limited to aryl substituents, alkyl substituents, and organic, organometallic, and inorganic functional group substituents.

Superstructure Bis-Pocket Porphyrins

A number of modified porphyrins have been synthesized to mimic various aspects of the enzymatic functions of heme proteins, especially oxygen binding (myoglobin and hemoglobin) and substrate oxidation (cytochrome P-450). See Suslick, K. S.; Reinert, T. J. *J. Chem. Ed.* 1985, 62, 974; Collman, J. P.; Zhang, X.; Lee, V. J.; Uffelman, E. S.; Brauman, J. I. *Science* 1993, 261, 1404; Collman, J. P.; Zhang, X. in *Comprehensive Supramolecular Chemistry*; Atwood, J. L.; Davies, J. E. D.; MacNicol, D. D.; Vogtel, F. Eds.; Pergamon: New York, 1996; vol. 5, pp. 1-32; Suslick, K. S.; van Deusen-Jeffries, S. in *Comprehensive Supramolecular Chemistry*; Atwood, J. L.; Davies, J. E. D.; MacNicol, D. D.; Vogtel, F. Eds.; Pergamon: New York, 1996; vol. 5, pp. 141-170; Suslick, K. S. in *Activation and Functionalization of Alkanes*; Hill, C. L., ed.; Wiley & Sons: New York, 1989; pp. 219-241. The notable property of many heme proteins is their remarkable substrate selectivity; the development of highly regioselective synthetic catalysts, however, is still at an early stage. Discrimination of one site on a molecule from another and distinguishing among many similar molecules presents a difficult and important challenge to both industrial and biological chemistry. See *Metalloporphyrins in Catalytic Oxidations*; Sheldon, R. A. Ed. Marcel Dekker: New York, 1994). Although the axial ligation properties of simple synthetic metalloporphyrins are well documented in literature, see Bampos, N.; Marvaud, V.; Sanders, J. K. M. *Chem. Eur. J.* 1998, 4, 325; Stibrany, R. T.; Vasudevan, J.; Knapp, S.; Potenza, J. A.; Emge, T.; Schugar, H. J. *J. Am. Chem. Soc.* 1996, 118, 3980, size and shape control of ligation to peripherally modified metalloporphyrins has been largely unexplored, with few notable exceptions, where only limited selectivities have been observed. See Bhyrappa, P.; Vijayanthimala, G.; Suslick, K. S. *J. Am. Chem. Soc.* 1999, 121, 262; Imai, H.; Nakagawa, S.; Kyuno, E. *J. Am. Chem. Soc.* 1992, 114, 6719.

The present invention includes the synthesis, characterization and remarkable shape-selective ligation of silylether-metalloporphyrin scaffolds derived from the reaction of 5,10,15,20-tetrakis(2',6'-dihydroxyphenyl)porphyrinatozinc (II) with t-butyltrimethylsilyl chloride, whereby the two faces of the Zn(II) porphyrin were protected with six, seven, or eight siloxyl groups. This results in a set of three porphyrins of nearly similar electronics but with different steric encumbrance around central metal atom present in the porphyrin. Ligation to Zn by classes of different sized ligands reveal shape selectivities as large as 10^7 .

A family of siloxyl-substituted bis-pocket porphyrins were prepared according to the scheme of FIG. 13. The abbreviations of the porphyrins that can be made in accordance with the scheme shown in FIG. 13 are as follows:

Zn(TPP), 5,10,15,20-tetraphenylporphyrinatozinc(II);
 Zn[(OH)₆PP], 5-phenyl-10,15,20-tris(2',6'-dihydroxyphenyl)porphyrinatozinc(II);
 Zn[(OH)₈PP], 5,10,15,20-tetrakis(2',6'-dihydroxyphenyl)porphyrinatozinc(II);
 Zn(Si₆PP), 5(phenyl)-10,15,20-trikis(2',6'-disilyloxyphenyl)porphyrinatozinc(II);
 Zn(Si₇OHPP), 5,10,15-trikis(2',6'-disilyloxyphenyl)-20-(2'-hydroxy-6'-silyloxyphenyl)porphyrinatozinc(II);

Zn(Si₈PP), 5,10,15,20-tetrakis(2',6'-disilyloxyphenyl)porphyrinatozinc(II). The synthesis of Zn[(OH)₆PP], Zn(Si₆PP), and Zn(Si₈PP) is detailed below. Zn[(OH)₆PP] and Zn[(OH)₈PP] were obtained (see Bhyrappa, P.; Vijayanthimala, G.; Suslick, K. S. *J. Am. Chem. Soc.* 1999, 121, 262) from demethylation (see Momenteau, M.; Mispelter, J.; Loock, B.; Bisagni, E. *J. Chem. Soc. Perkin Trans. 1*, 1983, 189) of corresponding free base methoxy compounds followed by zinc(II) insertion. The methoxy porphyrins were synthesized by acid catalysed condensation of pyrrole with respective benzaldehydes following Lindsey procedures. See Lindsey, J. S.; Wagner, R. W. *J. Org. Chem.* 1989, 54, 828. Metalation was done in methanol with Zn(O₂CCH₃)₂. The t-butyltrimethylsilyl groups were incorporated into the metalloporphyrin by stirring a DMF solution of hydroxyporphyrin complex with TBDMSiCl (i.e., t-butyltrimethylsilyl chloride) in presence of imidazole. See Corey, E. J.; Venkateswarlu, A. *J. Am. Chem. Soc.* 1972, 94, 6190. The octa (Zn(Si₈PP)), hepta (Zn(Si₇OHPP)), and hexa (Zn(Si₆PP)) silylether porphyrins were obtained from Zn[(OH)₈PP] and Zn[(OH)₆PP], respectively. The compounds were purified by silica gel column chromatography and fully characterized by UV-Visible, ¹H-NMR, HPLC, and MALDI-TOF MS.

The size and shape selectivities of the binding sites of these bis-pocket Zn silylether porphyrins were probed using the axial ligation of various nitrogenous bases of different shapes and sizes in toluene at 25° C. Zn(II) porphyrins were chosen because, in solution, they generally bind only a single axial ligand. Successive addition of ligand to the porphyrin solutions caused a red-shift of the Soret band typical of coordination to zinc porphyrin complexes. There is no evidence from the electronic spectra of these porphyrins for significant distortions of the electronic structure of the porphyrin. The binding constants (K_{eq}) and binding composition (always 1:1) were evaluated using standard procedures. See Collman, J. P.; Brauman, J. I.; Doxsee, K. M.; Halbert, T. R.; Hayes, S. E.; Suslick, K. S. *J. Am. Chem. Soc.* 1978, 100, 2761; Suslick, K. S.; Fox, M. M.; Reinert, T. J. *J. Am. Chem. Soc.* 1984, 106, 4522. The K_{eq} values of the silylether porphyrins with nitrogenous bases of different classes are compared with the sterically undemanding Zn(TPP) in FIGS. 14a, 14b, and 14c. It is worth noting the parallel between shape selectivity in these equilibrium measurements and prior kinetically-controlled epoxidation and hydroxylation. See Collman, J. P.; Zhang, X. in *Comprehensive Supramolecular Chemistry*; Atwood, J. L.; Davies, J. E. D.; MacNicol, D. D.; Vogtel, F. Eds.; Pergamon: New York, 1996; vol. 5, pp. 1-32; Suslick, K. S.; van Deusen-Jeffries, S. in *Comprehensive Supramolecular Chemistry*; Atwood, J. L.; Davies, J. E. D.; MacNicol, D. D.; Vogtel, F. Eds.; Pergamon: New York, 1996; vol. 5, pp. 141-170; Suslick, K. S. in *Activation and Functionalization of Alkanes*; Hill, C. L., ed.; Wiley & Sons: New York, 1989; pp. 219-241; Bhyrappa, P.; Young, J. K.; Moore, J. S.; Suslick, K. S. *J. Am. Chem. Soc.*, 1996, 118, 5708-5711. Suslick, K. S.; Cook, B. R. *J. Chem. Soc., Chem. Comm.* 1987, 200-202; Cook, B. R.; Reinert, T. J.; Suslick, K. S. *J. Am. Chem. Soc.* 1986, 108, 7281-7286; Suslick, K. S.; Cook, B. R.; Fox, M. M. *J. Chem. Soc., Chem. Commun.* 1985, 580-582. The selectivity for equilibrated ligation appears to be substantially larger than for irreversible oxidations of similarly shaped substrates.

The binding constants of silylether porphyrins are remarkably sensitive to the shape and size of the substrates relative to Zn(TPP). See FIGS. 14a, 14b, and 14c. The binding

constants of different amines could be controlled over a range of 10^1 to 10^7 relative to Zn(TPP). It is believed that these selectivities originate from strong steric repulsions created by the methyl groups of the *t*-butyldimethylsilyloxy substituents. The steric congestion caused by these bulky silylether groups is pronounced even for linear amines and small cyclic amines (e.g., azetidine and pyrrolidine).

There are very large differences in K_{eq} for porphyrins having three versus four silylether groups on each face (e.g., hexa- vs. octa-silylether porphyrins), as expected based on obvious steric arguments (see FIGS. 14a, 14b, and 14c). Even between the hexa- over hepta-silylether porphyrins, however, there are still substantial differences in binding behavior. It is believed that this is probably due to doming of the macrocycle in the hexa- and hepta-silylether porphyrins, which lessens the steric constraint relative to the octasilylether porphyrin. Such doming will be especially important in porphyrins whose two faces are not identical. The free hydroxy functionality of the hepta-silylether may play a role in binding of bi-functionalized ligands (e.g., free amino acids); for the simple amines presented here, however, we have no evidence of any special effects.

These silylether porphyrins showed remarkable selectivities for normal, linear amines over their cyclic analogues. For a series of linear amines (n-propylamine through n-decylamine), K_{eq} were very similar for each of the silylether porphyrins. In comparison, the relative K_{eq} for linear versus cyclic primary amines (FIG. 14a, n-butylamine vs. cyclohexylamine) were significantly different: $K_{eq}^{linear}/K_{eq}^{cyclic}$ ranges from 1 to 23 to 115 to >200 for Zn(TPP), Zn(Si₆PP), Zn(Si₇OHPP), and Zn(Si₈PP), respectively. The ability to discriminate between linear and cyclic compounds is thus established.

A series of cyclic 2° amines (FIG. 14b) demonstrate the remarkable size and shape selectivities of this family of bis-pocket porphyrins. Whereas the binding constants to Zn(TPP) with those amines are virtually similar. In contrast, the K_{eq} values for silylether porphyrins strongly depend on the ring size and its peripheral substituents. The effect of these shape-selective binding sites is clear, even for compact aromatic ligands with non-ortho methyl substituents (FIG. 14c).

The molecular structures of these silylether porphyrins explains their ligation selectivity. The x-ray single crystal structure of Zn(Si₈PP) has been solved in the triclinic P1bar space group. See Single crystal x-ray structure of Zn(Si8PP) shown in FIG. 15. As shown in FIG. 15, Zn(Si₆PP) (energy minimized molecular model) and Zn(Si₈PP) (single crystal x-ray structure) have dramatically different binding pockets. In the octasilylether porphyrin, the top access on both faces of the porphyrin is very tightly controlled by the siloxyl pocket. In contrast, the metal center of the hexasilylether porphyrin is considerably more exposed for ligation.

FIG. 15 illustrates molecular models of Zn(Si₆PP) (left column) and Zn(Si₈PP) (right column). The pairs of images from top to bottom are cylinder side-views, side-views, and top-views, respectively; space filling shown at 70% van der Waals radii; with the porphyrin carbon atoms shown in purple, oxygen atoms shown in red, silicon atoms in green, and Zn in dark red. The x-ray single crystal structure of Zn(Si₈PP) is shown; for Zn(Si₆PP), an energy-minimized structure was obtained using Cerius 2 from MSI.

In summary, a series of bis-pocket siloxyl metalloporphyrin complexes were prepared with sterically restrictive binding pockets on both faces of the macrocycle. Ligation to Zn by various nitrogenous bases of different sizes and shapes were investigated. Shape selectivities as large as 10^7 were

found, compared to unhindered metalloporphyrins. Fine-tuning of ligation properties of these porphyrins was also possible using pockets of varying steric demands. The shape selectivities shown here rival or surpass those of any biological system.

EXAMPLES OF SYNTHESIS OF SUPER STRUCTURES

Synthesis of 5-phenyl-10,15,20-tris(2',6'-dihydroxyphenyl)-porphyrinatozinc(II), Zn[(OH)₆PP]:

The free base 5-phenyl-10,15,20-tris(2',6'-dimethoxyphenyl)-porphyrin was synthesized by Lewis acid catalyzed condensation of 2,6-dimethoxybenzaldehyde and benzaldehyde with pyrrole (3:1:4 mole ratio) following the Lindsey procedure. See Lindsey, J. S.; Wagner, R. W. J. Org. Chem. 1989, 54, 828. The mixture of products thus formed was purified by silica gel column chromatography (if necessary, using CH₂Cl₂ as eluant). The isolated yield of the desired product was found to be 7%(wrt pyrrole used). The corresponding hydroxyporphyrins were obtained by demethylation with pyridine hydrochloride. See Momenteau, M.; Mispelter, J.; Loock, B.; Bisagni, E. J. Chem. Soc. Perkin Trans. 1, 1983, 189. After typical work-up known to those skilled in the art, the crude compound was purified by silica gel column chromatography using ethylacetate as eluant. The first fraction was Zn[(OH)₆PP], which was collected and the solvent was removed. The yield of the product was 90% (based on starting hydroxyporphyrin). ¹H NMR of H₂[(OH)₆PP] in acetone-d₆ (ppm): 8.96-8.79(m, 8H, b-pyrrole H), 8.24(m, 2H, o-H 5-Phenyl), 8.07 and 8.02(2s, 6H, —OH), 7.83(m, 3H, m,p-H 5-Phenyl), 7.50(t, 3H, p-H hydroxyphenyl), 6.90(d, 6H, m-H hydroxyphenyl), -2.69(s, 2H, imino-H). Elemental analysis, calcd. for C₄₄H₃₀O₆N₄·H₂O: C=72.5, H=4.4 and N=7.7%. Found C=72.7, H=4.4 and N=7.4%. The compound showed molecular ion peak at 711 (m/z calcd. for C₄₄H₃₀O₆N₄=710) in FAB-MS.

The Zn derivative was obtain by stirring methanol solution of H₂[(OH)₆PP] with excess Zn(O₂CCH₃)₂·2H₂O for 1 hour. Methanol was evaporated to dryness and the residue was dissolved in ethylacetate, washed with water, and the organic layer passed through anhyd. Na₂SO₄. The concentrated ethylacetate solution was passed through a silica gel column and the first band was collected as the desired product. The yield of the product was nearly quantitative. ¹H NMR of Zn(OH)₆PP in acetone-d₆ (ppm): 8.95-8.79(m, 8H, b-pyrrole H), 8.22(m, 2H, o-H 5-Phenyl), 7.79(m, 3H, m,p-H 5-Phenyl), 7.75 and 7.65(2s, 6H, —OH), 7.48(t, 3H,p-H hydroxyphenyl), 6.88(d, 6H, m-H hydroxyphenyl). Elemental analysis, calcd. for ZnC₄₄H₂₈O₆N₄·H₂O: C=66.7, H=3.8, N=7.1 and Zn=8.3%. Found C=66.4, H=3.8, N=6.7 and Zn=8.2%. The compound showed molecular ion peak at 774 (m/z calcd. for ZnC₄₄H₂₈O₆N₄=773) in FAB-MS.

Synthesis of 5-phenyl-10,15,20-tris(2',6'-disilyloxyphenyl)-porphyrinatozinc(II), Zn(Si₆PP):

The hexasilylether porphyrin was synthesized by stirring a DMF solution of 5-phenyl-10,15,20-tris(2',6'-dihydroxyphenyl)-porphyrinatozinc(II) (100 mg, 0.13 mmol) with *t*-butyldimethyl silylchloride (1.18 g, 7.8 mmol) in presence of imidazole (1.2 g, 17.9 mmol) at 60° C. for 24 h under nitrogen. After this period the reaction mixture was washed with water and extracted in CHCl₃. The organic layer was dried over anhyd. Na₂SO₄. The crude reaction mixture was

loaded on a short silica gel column and eluted with mixture of CHCl_3 /petether (1:1, v/v) to get rid of unreacted starting material and lower silylated products. The desired compound was further purified by running another silica gel column chromatography using mixture of CHCl_3 /petether (1:3, v/v) as eluant. The yield of the product was 60% based on starting hydroxyprophyrin.

^1H NMR in chloroform-d (ppm): 8.94-8.82(m, 8H, b-pyrrole H), 8.20(m, 2H, o-H 5-Phenyl), 7.74(m, 3H, m,p-H 5-Phenyl), 7.49(t, 3H, p-H hydroxyphenyl), 6.91(t, 6H, m —H hydroxyphenyl), -0.02 and -0.34(2s, 54H, t-butyl H), -0.43, -0.78 and -1.01(3s, 36H, methyl H). Elemental analysis, calcd. for $\text{ZnC}_{80}\text{H}_{112}\text{O}_6\text{N}_4\text{Si}_6$: C=65.8, H=7.7, N=3.8, Si=11.5 and Zn=4.5%. Found C=65.5, H=7.7, N=3.8, Si=11.2 and Zn=4.4%. The low resolution MALDI-TOF mass spectrum showed molecular ion peak at 1457 (m/z calcd. for $\text{ZnC}_{80}\text{H}_{112}\text{O}_6\text{N}_4\text{Si}_6=1458$).

Synthesis of 5,10,15-tris(2',6'-disilyloxyphenyl)-20-(2'-hydr-oxy-6'-silyloxyphenyl)porphyrinatozinc(II), [$\text{Zn}(\text{Si}_7\text{OHPP})$], and 5,10,15,20-tetrakis(2',6'-disilyloxyphenyl)porphyrinato-zinc(II), [$\text{Zn}(\text{Si}_8\text{PP})$]:

The synthesis of precursor porphyrin 5,10,15,20-tetrakis-(2',6'-dihydroxyphenyl)porphyrin and its Zn derivative was accomplished as reported earlier. See Bhyrappa, P.; Vijayanthimala, G.; Suslick, K. S. J. Am. Chem. Soc. 1999, 121, 262. The hepta- and octa-silylether porphyrins were synthesized by stirring DMF solution of 5,10,15,20-tetrakis(2',6'-dihydroxyphenyl)porphyrinatozinc(II) (100 mg, 0.12 mmol) with t-butylidimethyl silylchloride (1.45 g, 9.6 mmol) in presence of imidazole (1.50 g, 22.1 mmol) at 60° C. for 24 h under nitrogen. After usual work-up the mixture of crude products were loaded on a silica gel column and eluted with mixture of CHCl_3 /pet. ether (1:1, v/v) to remove unreacted starting material and lower silylated products. The major product isolated from this column is a mixture of hepta- and octa-silylated porphyrins. The mixture thus obtained was further purified by another silica gel column chromatography using mixture of CHCl_3 /pet. ether (1:3, v/v) as eluant. The first two bands were isolated as octa- and hepta-silylether porphyrin at 45% and 30% yield, respectively. Both the compounds were characterized by UV-Visible, ^1H NMR and MALDI-TOF spectroscopic techniques. The homogeneity of the sample was verified by HPLC.

For $\text{Zn}(\text{Si}_7\text{OHPP})$, ^1H NMR in chloroform-d (ppm): 8.91(m, 8H, b-pyrrole H), 7.50(m, 4H, p-H), 7.01-6.81(m, 8H, m-H), 0.11 to -0.03(12s, 105H, t-butyl and methyl H). Elemental analysis, calcd. for $\text{ZnC}_{86}\text{H}_{126}\text{O}_8\text{N}_4\text{Si}_7$: C=64.3, H=7.8, N=3.5, Si=12.3 and Zn=4.1%. Found C=63.6, H=8.1, N=3.5, Si=12.1 and Zn=3.9%. The low resolution MALDI-TOF mass spectrum showed molecular ion peak at 1604 (m/z calcd. for $\text{ZnC}_{86}\text{H}_{126}\text{O}_8\text{N}_4\text{Si}_7=1604$).

For $\text{Zn}(\text{Si}_8\text{PP})$, ^1H NMR in chloroform-d (ppm): 8.89(s, 8H, b-pyrrole H), 7.49(t, 4H, p-H), 6.92(d, 8H, m-H), 0.09(s, 72H, t-butyl H), -1.01(s, 48H, methyl H). Elemental analysis, calcd. for $\text{ZnC}_{92}\text{H}_{140}\text{O}_8\text{N}_4\text{Si}_8$: C=64.2, H=8.1, N=3.3, Si=13.1 and Zn=3.8%. Found C=63.5, H=8.4, N=3.3, Si=12.8 and Zn=4.0%. The low resolution MALDI-TOF mass spectrum showed molecular ion peak at 1719 (m/z calcd. for $\text{ZnC}_{92}\text{H}_{140}\text{O}_8\text{N}_4\text{Si}_8=1718$).

ADDITIONAL FEATURES OF THE PREFERRED EMBEDIMENTS OF THE INVENTION

Having demonstrated electronic differentiation and shape-selective distinction of analytes that bind to metal ions in

metallochromes, an important further goal is the differentiation of analytes that do not bind or bind only weakly to metal ions. Such analytes include acidic compounds, such as carboxylic acids, and certain organic compounds lacking ligatable functionality, such as simple alkanes, arenes, some alkenes and alkynes (especially if sterically hindered), and molecules sterically hindered as to preclude effective ligation. One approach that has been developed to achieve this goal in accordance with the present invention is to include in the sensor array other chemoresponsive dyes, including pH sensitive dyes (i.e., pH indicator or acid-base indicator dyes that change color upon exposure to acids or bases), and/or solvatochromic dyes (i.e., dyes that change color depending upon the local polarity of their micro-environment).

It has been discovered that the addition of pH sensitive dyes and solvatochromic dyes to other arrays containing metalloporphyrins as described above expands the range of analytes to which the arrays are sensitive, improves sensitivities to some analytes, and increases the ability to discriminate between analytes.

The present invention includes an artificial nose comprising an array, the array comprising at least a first dye and a second dye deposited directly onto a single support in a predetermined pattern combination, the combination of the dyes in the array having a distinct and direct spectral absorbance or reflectance response to an analyte wherein the first dye and the second dye are selected from the group consisting of chemoresponsive dyes, and the second dye is distinct from the first dye. In a preferred embodiment, the first dye is selected from the group consisting of porphyrin, chlorin, chlorophyll, phtahlocyanine, and salen and their metal complexes. In another preferred embodiment, the second dye is selected from the group of dyes consisting of acid-base indicator dyes and solvatochromic dyes.

The present invention includes a method of detecting an analyte comprising the steps of: (a) forming an array of at least a first dye and a second dye deposited directly onto a single support in a predetermined pattern combination, the combination of the dyes in the array having a distinct and direct spectral absorbance or reflectance response to an analyte wherein the first dye and the second dye are selected from the group consisting of chemoresponsive dyes, and the second dye is distinct from the first dye; (b) subjecting the array to an analyte; (c) inspecting the array for a distinct and direct spectral absorbance or reflectance response; and (d) correlating the distinct and direct spectral response to the presence of the analyte. In a preferred method, the first dye is selected from the group consisting of porphyrin, chlorin, chlorophyll, phtahlocyanine, and salen and their metal complexes. In another preferred method, the second dye is selected from the group of acid-base indicator dyes and solvatochromic dyes.

The present invention includes an artificial tongue comprising an array, the array comprising at least a first dye and a second dye deposited directly onto a single support in a predetermined pattern combination, the combination of the dyes in the array having a distinct and direct spectral absorbance or reflectance response to an analyte wherein the first dye and the second dye are selected from the group consisting of chemoresponsive dyes, and the second dye is distinct from the first dye. In a preferred embodiment, the first dye is selected from the group consisting of porphyrin, chlorin, chlorophyll, phtahlocyanine, and salen and their metal complexes. In another preferred embodiment, the second dye is selected from the group of dyes consisting of acid-base indicator dyes and solvatochromic dyes.

25

Chemoresponsive dyes are those dyes that change color, in either reflected or absorbed light, upon changes in their chemical environment. Three general classes of chemoresponsive dyes are (1) Lewis acid/base dyes, (2) pH indicator dyes, and (3) solvatochromic dyes.

Lewis acid/base dyes are those dyes that contain a Lewis acidic or basic center (where a Lewis acid is an electron pair acceptor and a Lewis base is an electron pair donor) and change color in response to changes in the Lewis acidity or basicity of their environment. A specific set of Lewis acid/base dyes includes dyes such as porphyrin, chlorin, chlorophyll, phtahlocyanine, and salen and their metal complexes.

pH indicator or acid-base indicator dyes are those that change color in response to changes in the proton acidity or basicity (also called Bronsted acidity or basicity) of their environment. A specific set of pH indicator dyes include Chlorphenol Red, Bromocresol Green, Bromocresol Purple, Bromothymol Blue, Phenol Red, Thymol Blue, Cresol Red, Alizarin, Mordant Orange, Methyl Orange, Methyl Red, Congo Red, Victoria Blue B, Eosin Blue, Fat Brown B, Benzopurpurin 4B, Phloxine B, Orange G, Metanil Yellow, Naphthol Green B, Methylene Blue, Safranin O, Methylene Violet 3RAX, Sudan Orange G, Morin Hydrate, Neutral Red, Disperse Orange 25, Rosolic Acid, Fat Brown RR, Cyanidin chloride, 3,6-Acridineamine, 6'-Butoxy-2,6-diamino-3,3'-azodipyridine, para-Rosaniline Base, Acridine Orange Base, Crystal Violet, and Malachite Green Carbinol Base.

Solvatochromic dyes are those that change color in response to changes in the general polarity of their environment, primarily through strong dipole-dipole interactions. To some extent, all dyes inherently are solvatochromic, although some are much more responsive than others. A specific set of highly responsive solvatochromic dyes include Reichardt's Dye and Nile Red.

It has been discovered that the following pH indicator (i.e., acid-base indicator) dyes and solvatochromic dyes are useful to expand the range of analytes to which the arrays containing metalloporphyrins are sensitive, improve sensitivities to some analytes, and increase the ability to discriminate between analytes. Those skilled in the art will recognize that other modifications and variations in the choice of such auxiliary dyes may be made in addition to those described and illustrated herein without departing from the spirit and scope of the present invention. Accordingly, the choice of dyes described and illustrated herein should be understood to be illustrative only and not limiting upon the scope of the present invention.

Chlorphenol Red
Molecular Formula: $C_{19}H_{12}Cl_2O_5S$
Molecular Weight: 423.28
CAS: 4430-20-0

Transition interval: pH 4.8 (yellow) to pH 6.7 (violet)

Bromocresol Green
Synonyms: 3',3'',5',5''Tetrabromo-m-cresolsulfonphthalein;
Bromocresol Green
Molecular Formula: $C_{21}H_{14}Br_4O_5S$
Molecular Weight: 698.04
CAS: 76-60-8

pH = 3.8 yellow
= 5.4 blue

26

Bromocresol Purple
Synonyms: 5',5'' dibromo-m-cresolsulfonphthalein; Bromocresol Purple

Molecular Formula: $C_{21}H_{16}Br_2O_5S$

5 Molecular Weight: 698.04

CAS: 115-40-2

pH = 5.2 yellow

10 = 6.8 blue

Bromothymol Blue

15 Synonyms: 3',3''-Dibromothymolsulfonphthalein; Bromthymol Blue

Molecular Formula: $C_{27}H_{28}Br_2O_5S$

Molecular Weight: 624.41

CAS: 76-59-5

20 pH = 6.0 yellow

= 7.6 blue

25 Phenol Red

Synonyms: Phenolsulfonphthalein

Molecular Formula: $C_{19}H_{14}O_5S$

30 Molecular Weight: 354.38

CAS: 143-74-8

pH = 6.8 yellow

35 = 8.2 red

40 Thymol Blue

Synonyms: Thymolsulfonphthalein

Molecular Formula: $C_{27}H_{30}O_5S$

Molecular Weight: 466.60

CAS: 76-61-9

45 pH = 1.2 red

= 2.8 yellow

= 8 yellow

50 = 9.2 blue

Cresol Red

55 Synonyms: Phenol, 4,4'-(1,1-dioxido-3H-2,1-benzoxathiol-3-ylidene)bis[2-methyl-(9CI)]

Molecular Formula: $C_{21}H_{18}O_5S$

Molecular Weight: 382.43

CAS: 1733-12-6

60 pH 1.8 (orange) to pH 2.0 (yellow); Transition interval (alkaline): pH 7.0 (yellow) to pH 8.8 (violet)

Alizarin

65 Synonyms: 1,2-Dihydroxyanthraquinone, 9,10-Anthracenedione, 1,2-dihydroxy-(9CI)

Molecular Formula: $C_{14}H_8O_4$

Molecular Weight: 240.22

27

pH = 5.5 yellow
 = 6.8 red
 = 10.1 red
 = 12.1 violet

Mordant Orange 1

Synonyms: Alizarin Yellow R, C.I. 14030, 5-(4-nitrophenylazo)salicylic acid

Molecular Formula: $C_{13}H_9N_3O_5$

Molecular Weight: 287.23

CAS: 2243-76-7

Methyl Orange

Synonyms: 4-(p-[Dimethylamino]phenylazo)benzenesulfonic acid, sodium salt Acid Orange 52

Molecular Formula: $C_{14}H_{14}N_3O_3SNa$

Molecular Weight: 327.3

pH 3.0 (pink)—pH 4.4 (yellow)

Methyl Red

Synonyms: 4-Dimethylaminoazobenzene-2'-carboxylic acid; 2-(4-Dimethylaminophenylazo)benzoic acid

Molecular Formula: $C_{15}H_{15}N_3O_2$

Molecular Weight: 269.31

CAS: 493-52-7

pH = 4.2 pink
 = 6.2 yellow

Reichardt's Dye

Synonyms: [2,6-diphenyl-4-(2,4,6-triphenylpyridinio)phenolate]

Molecular Formula: $C_{41}H_{29}NO$

Molecular Weight: 551.69

CAS: 10081-39-7

Nile Red

Synonyms: 5H-Benzo[a]phenoxazin-5-one, 9-(diethylamino)-(7Cl, 8Cl, 9Cl), 9-(Diethylamino)-5H-benzo[a]phenoxazin-5-one; Nile Blue A oxazone

Molecular Formula: $C_{20}H_{18}N_2O_2$

Molecular Weight: 318.38

CAS: 7385-67-3

Congo Red

Molecular Formula: $C_{32}H_{24}N_6O_6S_2 \cdot Na_2$

Molecular Weight: 696.67

CAS: 573-58-0

pH range: blue 3.1-4.9 red

Victoria Blue B

Synonyms: Basic Blue 26, C.I. 44045

Molecular Formula: $C_{33}H_{32}ClN_3$

Molecular Weight: 506.10

CAS: 2580-56-5

Eosin Blue

Synonyms: (Acid Red 91, C.I. 45400, 4',5'-dibromo-2',7'-dinitrofluorescein, disodium salt)

Molecular Formula: $C_{20}H_8Br_2N_2O_9$

Molecular Weight: 624.08

CAS: 548-24-3

28

Fat Brown B

Synonyms: Solvent red 3

Molecular Formula: $C_{18}H_{16}N_2O_2$

Molecular Weight: 292.3

5 CAS: 6535-42-8

Benzopurpurin 4B

Synonyms: (C.I. 23500, Direct Red 2)

Molecular Formula: $C_{34}H_{28}N_6O_6S_2$

Molecular Weight: 724.73

10 CAS: 992-59-6

pH range: violet 1.2-3.8 yellow

Phloxine B

15 Molecular Formula: $C_{20}H_4Br_4Cl_4O_5$

CAS: 18472-87-2

pH range: colorless 2.1-4.1 pink

Orange G

20 Synonyms: 1-Phenylazo-2-naphthol-6,8-disulfonic acid disodium salt

Molecular Formula: $C_{16}H_{10}N_2Na_2O_7S_2$

Molecular Weight: 452.

pH range: yellow 11.5-14.0 pink

25 Metanil Yellow

Synonyms: (Acid Yellow 36, C.I. 13065)

Molecular Formula: $C_{18}H_{15}N_3O_3S \cdot Na$

Molecular Weight: 375.38

30 CAS: 587-98-4

pH 1.5 (red) to pH 2.7 (yellow)

Naphthol Green B

Synonyms: (Acid Green 1, C.I. 10020)

Molecular Formula: $C_{10}H_7NO_5S$

35 Molecular Weight: 878.47

CAS: 19381-50-1

Methylene Blue

Synonyms: (Basic Blue 9, C.I. 52015)

40 Molecular Formula: $C_{16}H_{18}ClN_3S$

Molecular Weight: 373.90

CAS: 7220-79-3

Safranine O

45 Synonyms: (C.I. 50240, 3,7-diamino-2,8-dimethyl-5-phenylphenazinium chloride)

Molecular Formula: $C_{20}H_{19}ClN_4$

Molecular Weight: 350.85

CAS: 477-73-6

50 Methylene Violet 3RAX

Synonyms: [3-amino-7-(diethylamino)-5-phenylphenazinium chloride, C.I. 50206, N,N-diethylphenosafranine]

Molecular Formula: $C_{22}H_{23}ClN_4$

Molecular Weight: 378.91

55 CAS: 4569-86-2

Sudan Orange G

Synonyms: [C.I. 11920, 4-(phenylazo)resorcinol, Solvent Orange 1]

60 Molecular Formula: $C_6H_5N=NC_6H_3-1,3-(OH)_2$

Molecular Weight: 214.22

CAS: 2051-85-6

Morin Hydrate

65 Synonyms: (2',3,4',5,7-pentahydroxyflavone)

Molecular Formula: $C_{15}H_{10}O_7$

Molecular Weight: 302.24 Neutral Red

29

Molecular Formula: $C_{15}H_{16}N_4.HCl$
 Molecular Weight: 288.78
 CAS: 553-24-2

pH = 6.8 red
 = 8.0 yellow

Disperse Orange 25

Molecular Formula: $C_{17}H_{17}N_5$ 02
 Molecular Weight: 323.36
 CAS: 31482-56-1

Rosolic Acid

Molecular Formula: $C_{20}H_{16}O_3$
 Molecular Weight: 290.32
 CAS: 603-45-2

pH = 5.0 yellow
 = 6.8 pink

Fat Brown RR

Molecular Formula: $C_{16}H_{14}N_4$
 Molecular Weight: 262.32
 CAS: 6416-57-5

Cyanidin chloride

Molecular Formula: $C_{15}H_{11}O_6.Cl$
 Molecular Weight: 322.7
 CAS: 528-58-5

3,6-Acridineamine

Molecular Formula: $C_{13}H_{11}N_3$
 Molecular Weight: 209.25
 CAS Number: 92-62-6

6'-Butoxy-2,6-diamino-3,3'-azodipyridine

Synonym: Azodipyridine
 Molecular Formula: $C_{14}H_{18}N_6O$
 Molecular Weight: 286.34
 CAS: 617-19-6

para-Rosaniline Base

Synonym: Rosaniline
 Molecular Formula: $C_{19}H_{19}N_3O$
 Molecular Weight: 305.4
 CAS: 25620-78-4

Acridine Orange Base

Molecular Formula: $C_{17}H_{19}N_3$
 Molecular Weight: 265.36
 CAS: 494-38-2

30

Crystal Violet

Molecular Formula: $C_{25}H_{30}N_3.Cl$
 Molecular Weight: 407.99
 CAS: 548-62-9

5

pH = 0 yellow
 = 1.8 blue

10

Malachite Green Carbinol Base

Molecular Formula: $C_{23}H_{26}N_2O$
 Molecular Weight: 346.48
 CAS: 510-13-4

15

pH = 0.2 yellow

20

= 1.8 blue-green

In a preferred embodiment, a low volatility liquid, e.g., a plasticizer, is used in an array of the present invention to keep the dyes in the array from crystallizing and to enhance then response of the array to an analyte. Examples of suitable low volatility liquids include, but are not limited to DOW CORNING 704 silicone diffusion pump fluid (Molecular Weight: 484.82, Density: 1.070, CAS Number: 3982-82-9), and diundecyl phthalate (Molecular Weight: 474.73, Density: 0.950, CAS Number: 3648-20-2, Formula: $C_{30}H_{50}O_4$, Boiling Point ($^{\circ}C$): 523 at 760 torr), dibutyl phthalate (Molecular Weight: 278.4, Density: 1.048, CAS Number: 84-74-2, Formula: $C_{16}H_{22}O_4$, Boiling Point ($^{\circ}C$): 340 at 760 torr), diisopropyl phthalate (Molecular Weight: 250.3, Density: 1.063, CAS Number: 605-45-8, Formula: $C_{14}H_{18}O_4$), squalane (Molecular Weight: 422.83, Density: 0.810, CAS Number: 111-01-3, Formula: $C_{30}H_{62}$, Boiling Point ($^{\circ}C$): 176 at 0.05 torr), triethylene glycol dimethyl ether (synonym: Triglyme, Molecular Weight: 178.23, Density: 0.986, CAS Number: 112-49-2, Formula: $C_8H_{18}O_4$, Boiling Point ($^{\circ}C$): 216 at 760 torr), and tetraethylene glycol dimethyl ether (synonym: Tetraglyme, Molecular Weight: 222.28, Density: 1.009, CAS Number: 143-24-8, Formula: $C_{10}H_{22}O_5$, Boiling Point ($^{\circ}C$): 275-276 at 760 torr).

FIG. 16 illustrates an array containing illustrative examples of porphyrin, metalloporphyrin, acid-base indicator, and solvatochromatic dyes. Typical sizes can range from 0.5 mm to 2 cm on a side. Linear, hexagonal, or rectangular arrays are also easily used. From left to right and top to bottom the identities and colors of the dyes used in the illustrative example of FIG. 16 are listed in Table 11 as follows (the exact colors depend, among other things, upon scanner settings).

TABLE 11

(Summarizing the Dyes and Colors in FIG. 16, i.e., "Dye - Color")

SnTPPCl ₂ - Light Green	CoTPP - Peach	CrTPPCl - Green	MnTPPCl - Green	FeTPPCl - Light Brownish Green	CuTPP - Salmon
AgTPP - Salmon	NiTPP - Pink	InTPPCL - Tan	IrTPPCl - Pink	ZnTPP - Salmon	FeTFPPCl - Olive
ZnSi ₆ PP - Pink	ZnSi ₇ OHPP - Deep Pink	ZnSi ₈ PP - Pink	H ₂ TPP - Carmel	H ₂ FPP - Light Brown	Alizarin basic - Violet
Me Red - Orange	BCP - Dark Green	BCPbasic - Blue	BTB - Dark Yellow	BTB basic - Blue	Ph Red basic - Lavender

TABLE 11-continued

(Summarizing the Dyes and Colors in FIG. 16, i.e., "Dye - Color")

Nile Red - Violet	BCG - Blue	BCG basic - Blue	CresRed - Brownish Purple	CresRed basic - Purple	CP Red - Purple
R Dye - Light Blue	TB - Yellow	TB basic - Greenish Gray	MeOr - Yellow	MeOr basic - Orangish Brown	CP Red basic - Bluish Purple

where TPP=5,10,15,20-tetraphenylporphyrinate(-2);
 Zn (Si₆PP)=5(phenyl)-10,15,29-trikis(2',6'-disilyloxyphenyl)porphyrinatozinc(II);
 Zn(Si₇OHPP)=5,10,15trikis(2',6'-disilyloxyphenyl)-20-(2'-hydroxy-6'-silyloxyphenyl)porphyrinatozinc(II);
 Zn(Si₈PP)=5,10,15,20-tetrakis(2',6'-disilyloxyphenyl)porphyrinatozinc(II);
 Me Red=Methyl Red;
 BCP=Bromocresol Purple;
 BTB=Bromothymol Blue;
 Ph Red=Phenol Red;
 BCG=Bromocresol Green;
 CresRed=Cresol Red;
 CP Red=Chlorophenol Red;
 R Dye=Reichardt's Dye;
 TB=Thymol Blue;
 MeOr=Methyl Orange; and
 basic indicates the addition of KOH until the color of the basic form of the indicator dye was observed.

Note: DOW CORNING 704 silicone diffusion pump fluid (Molecular Weight: 484.82, Density: 1.070, CAS Number: 3982-82-9) was added to all porphyrin solutions: 40 µl/ml.

15 FIG. 17 illustrates the response of the array described in FIG. 16 to acid vapors, specifically formic acid, acetic acid, iso-valeric acid, and 3-methyl-2-hexenoic acid. As shown in FIG. 17 and summarized in Table 12 below, the color changes of each dye in response to a particular analyte are shown as color difference maps, as follows (the exact colors depend, among others things, upon scanner settings). The color changes are derived simply by comparing the before exposure and after exposure colors and subtracting the two images (i.e., the absolute value of the difference of the red values becomes the new red value in the color difference map; etc. for green values and blue values). If there is no change in the red, green, and blue color values of a dye in the after-exposure image, then the color difference map will show black (i.e., red value=green value=blue value=0).

TABLE 12

(Summarizing the Dyes and Color Changes in FIG. 17, i.e. "Dye - Difference Map Color")

(Analyte: Formic Acid 140 ppb)					
SnTPPCL ₂ - Black (no change)	CoTPP - Black (no change)	CrTPPCL - Black (no change)	MnTPPCL - Black (no change)	FeTPPCL - Faint Blue Periphery	CuTPP - Black (no change)
AgTPP - Black (no change)	NiTPP - Black (no change)	InTPPCL - Black (no change)	IrTPPCL - Black (no change)	ZnTPP - Black (no change)	FeTFPPCL - Black (no change)
ZnSi ₆ PP - Black (no change)	ZnSi ₇ OHPP - Black (no change)	ZnSi ₈ PP - Black (no change)	H ₂ TPP - Black (no change)	H ₂ FPP - Black (no change)	Alizarin basic - Dark Blue
Me Red - Black (no change)	BCP - Yellow	BCP basic - White	BTB - Black (no change)	BTB basic - Red Periphery w/Yellow Center	Ph Red basic - Green
Nile Red - Black (no change)	BCG - Black (no change)	BCG basic - Dark Purple	CresRed - Black (no change)	CresRed basic - Light Green	CP Red - Black (no change)
R Dye - Black (no change)	TB - Black (no change)	TB basic - Black (no change)	MeOr - Green and Purple	MeOr basic - Dark Purple	CP Red basic - Yellow Periphery and Purple center
(Analyte: Formic Acid 210 ppb)					
SnTPPCL ₂ - Black (no change)	CoTPP - Black (no change)	CrTPPCL - Black (no change)	MnTPPCL - Black (no change)	FeTPPCL - Black (no change)	CuTPP - Black (no change)
AgTPP - Black (no change)	NiTPP - Black (no change)	InTPPCL - Black (no change)	IrTPPCL - Black (no change)	ZnTPP - Black (no change)	FeTFPPCL - Black (no change)

TABLE 12-continued

(Summarizing the Dyes and Color Changes in FIG. 17, i.e. "Dye - Difference Map Color")					
ZnSi ₆ PP - Black (no change)	ZnSi ₇ OH PP - Black (no change)	ZnSi ₈ PP - Black (no change)	H ₂ TPP - Black (no change)	H ₂ FPP - Black (no change)	Alizarin basic - Black (no change)
Me Red - Black (no change)	BCP - Red	BCP basic - Yellow	BTB - Black (no change)	BTB basic - Red	Ph Red basic - Green
Nile Red - Black (no change)	BCG - Black (no change)	BCG basic - Red periphery	CresRed - Black (no change)	CresRed basic - Green	CP Red - Black (no change)
R Dye - Black (no change)	TB - Black (no change)	TB basic - Black (no change)	MeOr - Black (no change)	MeOr basic - Black (no change)	CP Red basic - Yellow
					Periphery and Purple Center
(Analyte: Formic Acid 340 ppb)					
SnTPPCL ₂ - Black (no change)	CoTPP - Black (no change)	CrTPPCL - Black (no change)	MnTPPCL - Black (no change)	FeTPPCL - Black (no change)	CuTPP - Black (no change)
AgTPP - Black (no change)	NiTPP - Black (no change)	InTPPCL - Black (no change)	IrTPPCL - Black (no change)	ZnTPP - Black (no change)	FeTFPPCL - Black (no change)
ZnSi ₆ PP - Black (no change)	ZnSi ₇ OHPP - Black (no change)	ZnSi ₈ PP - Black (no change)	H ₂ TPP - Black (no change)	H ₂ FPP - Black (no change)	Alizarin basic - Green and Purple
Me Red - Black (no change)	BCP - Yellow	BCP basic - White	BTB - Black (no change)	BTB basic - Yellow	Ph Red basic - Green
Nile Red - Black (no change)	BCG - Red	BCG basic - Red and Purple	CresRed - Black (no change)	CresRed basic - Light Green	CP Red - Green
R Dye - Black (no change)	TB - Black (no change)	TB basic - Black (no change)	MeOr - Blue	MeOr basic - Purple	CP Red basic - White
(Analyte: Formic Acid 680 ppb)					
SnTPPCL ₂ - Black (no change)	CoTPP - Black (no change)	CrTPPCL - Black (no change)	MnTPPCL - Black (no change)	FeTPPCL - Black (no change)	CuTPP - Black (no change)
AgTPP - Black (no change)	NiTPP - Black (no change)	InTPPCL - Black (no change)	IrTPPCL - Black (no change)	ZnTPP - Black (no change)	FeTFPPCL - Black (no change)
ZnSi ₆ PP - Black (no change)	ZnSi ₇ OHPP - Black (no change)	ZnSi ₈ PP - Black (no change)	H ₂ TPP - Black (no change)	H ₂ FPP - Black (no change)	Alizarin basic - Green and Purple
Me Red - Black (no change)	BCP - Yellow	BCP basic - White	BTB - Black (no change)	BTB basic - Red	Ph Red basic - Green
Nile Red - Black (no change)	BCG Red and Purple	BCG basic - Red and Purple	CresRed - Black (no change)	CresRed basic - Green	CP Red - Black (no change)
R Dye - Black (no change)	TB - Black (no change)	TB basic - Black (no change)	MeOr - Light blue	MeOr basic - Purple	CP Red basic - White
(Analyte: Acetic Acid 170 ppb)					
SnTPPCL ₂ - Black (no change)	CoTPP - Black (no change)	CrTPPCL - Black (no change)	MnTPPCL - Black (no change)	FeTPPCL - Black (no change)	CuTPP - Black (no change)
AgTPP - Black (no change)	NiTPP - Black (no change)	InTPPCL - Black (no change)	IrTPPCL - Black (no change)	ZnTPP - Black (no change)	FeTFPPCL - Black (no change)
ZnSi ₆ PP - Black (no change)	ZnSi ₇ OHPP - Black (no change)	ZnSi ₈ PP - Black (no change)	H ₂ TPP - Black (no change)	H ₂ FPP - Black (no change)	Alizarin basic - Black (no change)
Me Red - Black (no change)	BCP - Red	BCP basic - Orange	BTB - Black (no change)	BTB basic - Red	Ph Red basic - Black (no change)

TABLE 12-continued

(Summarizing the Dyes and Color Changes in FIG. 17, i.e. "Dye - Difference Map Color")					
Nile Red - Black (no change)	BCG - Purple and Orange	BCG basic - Purple	CresRed - Black (no change)	CresRed basic - Black (no change)	CP Red - Black (no change)
R Dye - Black (no change)	TB - Black (no change)	TB basic - Black (no change)	MeOr - Black (no change)	MeOr basic - Black (no change)	CP Red basic - Black (no change)
(Analyte: Acetic Acid 250 ppb)					
SnTPPCL ₂ - Black (no change)	CoTPP - Black (no change)	CrTPPCL - Black (no change)	MnTPPCL - Black (no change)	FeTPPCL - Black (no change)	CuTPP - Black (no change)
AgTPP - Black (no change)	NiTPP - Black (no change)	InTPPCL - Black (no change)	IrTPPCL - Black (no change)	ZnTPP - Black (no change)	FeTFPPCL - Black (no change)
ZnSi ₆ PP - Black (no change)	ZnSi ₇ OHPP - Black (no change)	ZnSi ₈ PP - Black (no change)	H ₂ TPP - Black (no change)	H ₂ FPP - Black (no change)	Alizarin basic - Black (no change)
Me Red - Black (no change)	BCP - Yellow with Red Center	BCP basic - Red	BTB - Black (no change)	BTB basic - Red	Ph Red basic - Green
Nile Red - Black (no change)	BCG - Orange	BCG basic - Red and Purple	CresRed - Black (no change)	CresRed basic - Black (no change)	CP Red - Black (no change)
R Dye - Black (no change)	TB - Black (no change)	TB basic - Black (no change)	MeOr - Black (no change)	MeOr basic - Black (no change)	CP Red basic - White
(Analyte: Acetic Acid 340 ppb)					
SnTPPCL ₂ - Black (no change)	CoTPP - Black (no change)	CrTPPCL - Black (no change)	MnTPPCL - Black (no change)	FeTPPCL - Black (no change)	CuTPP - Black (no change)
AgTPP - Black (no change)	NiTPP - Black (no change)	InTPPCL - Black (no change)	IrTPPCL - Black (no change)	ZnTPP - Black (no change)	FeTFPPCL - Black (no change)
ZnSi ₆ PP - Black (no change)	ZnSi ₇ OHPP - Black (no change)	ZnSi ₈ PP - Black (no change)	H ₂ TPP - Black (no change)	H ₂ FPP - Black (no change)	Alizarin basic - Black (no change)
Me Red - Black (no change)	BCP - Yellow	BCP basic - Yellow	BTB - Black (no change)	BTB basic - Orange	Ph Red basic - Green
Nile Red - Black (no change)	BCG - Faint Orange and Purple	BCG basic - Purple	CresRed - Black (no change)	CresRed basic - Green	CP Red - Black (no change)
R Dye - Black (no change)	TB - Black (no change)	TB basic - Black (no change)	MeOr - Black (no change)	MeOr basic - Black (no change)	CP Red basic - White
(Analyte: Acetic Acid 650 ppb)					
SnTPPCL ₂ - Black (no change)	CoTPP - Black (no change)	CrTPPCL - Black (no change)	MnTPPCL - Black (no change)	FeTPPCL - Black (no change)	CuTPP - Black (no change)
AgTPP - Black (no change)	NiTPP - Black (no change)	InTPPCL - Black (no change)	IrTPPCL - Black (no change)	ZnTPP - Black (no change)	FeTFPPCL - Black (no change)
ZnSi ₆ PP - Black (no change)	ZnSi ₇ OHPP - Black (no change)	ZnSi ₈ PP - Black (no change)	H ₂ TPP - Black (no change)	H ₂ FPP - Black (no change)	Alizarin basic - Faint Green
Me Red - Black (no change)	BCP - Yellow and Orange	BCP basic - Faint Yellow	BTB - Orange	BTB basic - Yellow	Ph Red basic - Green
Nile Red - Black (no change)	BCG - Black (no change)	BCG basic - Purple	CresRed - Black (no change)	CresRed basic - White	CP Red - Faint Green
R Dye - Black (no change)	TB - Black (no change)	TB basic - Black (no change)	MeOr - Black (no change)	MeOr basic - Green	CP Red basic - White

TABLE 12-continued

(Summarizing the Dyes and Color Changes in FIG. 17, i.e. "Dye - Difference Map Color")					
(Analyte: Iso-Valeric Acid 280 ppb)					
SnTPPCL ₂ - Black (no change)	CoTPP - Black (no change)	CrTPPCL - Black (no change)	MnTPPCL - Black (no change)	FeTPPCL - Black (no change)	CuTPP - Black (no change)
AgTPP - Black (no change)	NiTPP - Black (no change)	InTPPCL - Black (no change)	IrTPPCL - Black (no change)	ZnTPP - Black (no change)	FeTFPPC - Black (no change)
ZnSi ₆ PP - Black (no change)	ZnSi ₇ OHPP - Black (no change)	ZnSi ₈ PP - Black (no change)	H ₂ TPP - Black (no change)	H ₂ FPP - Black (no change)	Alizarin basic - Black (no change)
Me Red - Black (no change)	BCP - Red - Black (no change)	BCP basic - Faint Red	BTB - Black (no change)	BTB basic - Orange	Ph Red basic - Orange
Nile Red - Black (no change)	BCG - Faint Purple Periphery	BCG basic - Red Periphery	CresRed - Black (no change)	CresRed basic - Dark Green	CP Red - Black (no change)
R Dye - Black (no change)	TB - Red and Purple Periphery	TB basic - Red Periphery	MeOr - Green Center	MeOr basic - Green Periphery	CP Red basic - Green Periphery
(Analyte: Iso-Valeric Acid 420 ppb)					
SnTPPCL ₂ - Black (no change)	CoTPP - Black (no change)	CrTPPCL - Black (no change)	MnTPPCL - Black (no change)	FeTPPCL - Black (no change)	CuTPP - Black (no change)
AgTPP - Black (no change)	NiTPP - Black (no change)	InTPPCL - Black (no change)	IrTPPCL - Black (no change)	ZnTPP - Black (no change)	FeTFPPC - Black (no change)
ZnSi ₆ PP - Black (no change)	ZnSi ₇ OHPP - Black (no change)	ZnSi ₈ PP - Black (no change)	H ₂ TPP - Black (no change)	H ₂ FPP - Black (no change)	Alizarin basic - Black (no change)
Me Red - Black (no change)	BCP - Red	BCP basic - Faint Green and orange	BTB - Black (no change)	BTB basic - Orange and Yellow	Ph Red basic - Faint Orange and Green
Nile Red - Black (no change)	BCG - Orange	BCG basic - Orange Periphery	CresRed - Black (no change)	CresRed basic - Green	CP Red - Black (no change)
R Dye - Black (no change)	TB - Black (no change)	TB basic - Black (no change)	MeOr - Green	MeOr basic - Green	CP Red basic - Green
(Analyte: Iso-Valeric Acid 850 ppb)					
SnTPPCL ₂ - Faint blue	CoTPP - Faint Purple	CrTPPCL - Faint Purple	MnTPPCL - Faint Purple	FeTPPCL - Faint Purple	CuTPP - Black (no change)
AgTPP - Faint Blue	NiTPP - Black (no change)	InTPPCL - Faint Pink	IrTPPCL - Black (no change)	ZnTPP - Black (no change)	FeTFPPC - Black (no change)
ZnSi ₆ PP - Faint Blue	ZnSi ₇ OHPP - Faint Blue	ZnSi ₈ PP - Black (no change)	H ₂ TPP - Faint Blue	H ₂ FPP - Black (no change)	Alizarin basic - Black (no change)
Me Red - Black (no change)	BCP - White and Red	BCP basic - Yellow and Red	BTB - Blue and Red	BTB basic - Red and Yellow	Ph Red basic - Yellow and Red
Nile Red - Black (no change)	BCG - White, Red and Blue	BCG basic - White and Red Periphery	CresRed - Purple Periphery	CresRed basic - Light Green	CP Red - Faint Orange
R Dye - Faint Red	TB - Light Blue Periphery	TB basic - Purple Periphery and Red Center	MeOr - Green and Blue	MeOr basic - Light Green	CP Red basic - Light Green
(Analyte: Iso-Valeric Acid 1700 ppb)					
SnTPPCL ₂ - Black (no change)	CoTPP - Black (no change)	CrTPPCL - Black (no change)	MnTPPCL - Black (no change)	FeTPPCL - Black (no change)	CuTPP - Black (no change)
AgTPP - Black (no change)	NiTPP - Black (no change)	InTPPCL - Black (no change)	IrTPPCL - Black (no change)	ZnTPP - Black (no change)	FeTFPPC - Black (no change)

TABLE 12-continued

(Summarizing the Dyes and Color Changes in FIG. 17, i.e. "Dye - Difference Map Color")					
ZnSi ₆ PP - Black (no change)	ZnSi ₇ OHPP - Black (no change)	ZnSi ₈ PP - Black (no change)	H ₂ TPP - Black (no change)	H ₂ FPP - Black (no change)	Alizarin basic - Faint Purple
Me Red - Black (no change)	BCP - Red	BCP basic - White	BTB - Black (no change)	BTB basic - White	Ph Red basic - White and Purple
Nile Red - Black (no change)	BCG - Red and Purple	BCG basic - White, Red, and Purple	CresRed - Black (no change)	CresRed basic - White	CP Red - Black (no change)
R Dye - Black (no change)	TB - Black (no change)	TB basic - Faint Red	MeOr - Black (no change)	MeOr basic - Faint Green	CP Red basic - Green
(Analyte: 3-Methyl-2-hexenoic Acid 12 ppb)					
SnTPPCL ₂ - Black (no change)	CoTPP - Black (no change)	CrTPPCL - Black (no change)	MnTPPCL - Black (no change)	FeTPPCL - Black (no change)	CuTPP - Black (no change)
AgTPP - Black (no change)	NiTPP - Black (no change)	InTPPCL - Black (no change)	IrTPPCL - Black (no change)	ZnTPP - Black (no change)	FeTFPPCL - Black (no change)
ZnSi ₆ PP - Black (no change)	ZnSi ₇ OHPP - Black (no change)	ZnSi ₈ PP - Black (no change)	H ₂ TPP - Black (no change)	H ₂ FPP - Black (no change)	Alizarin basic - Black (no change)
Me Red - Black (no change)	BCP - Faint Purple	BCP basic - White and Purple	BTB - Black (no change)	BTB basic - Red	Ph Red basic - Purple and Green
Nile Red - Black (no change)	BCG - Faint Red and Purple	BCG basic - Faint White and Purple	CresRed - Black (no change)	CresRed basic - Light Blue and Green	CP Red - Black (no change)
R Dye - Black (no change)	TB - Black (no change)	TB basic - Black (no change)	MeOr - Black (no change)	MeOr basic - Blue and Green	CP Red basic - Green

FIG. 18 illustrates a preferred array containing illustrative examples of porphyrin, metalloporphyrin, acid-base indicator, and solvatochromatic dyes. Typical sizes of the array can range from 0.5 mm to 2 cm on a side. Linear, hexagonal or rectangular arrays are also easily used. From left to right and

top to bottom the identities and colors of the dyes used in the illustrative example of FIG. 18 are listed in Table 13 as follows (the exact colors depend, among other things, upon scanner setting).

TABLE 13

(Summarizing the Dyes and Colors in FIG. 18, i.e., "Dye - Color")					
SnTPPCL ₂ - Light Green	CoTPP - Tan	CrTPPCL - Green with Dark Green Center	MnTPPCL - Green	FeTPPCL - Light Green	CuTPP - Light Pink
Zn(C ₃ F ₇) ₄ P - Gray	ZnF ₂ PP - Light Pink	InTPPCL - Reddish Beige	ZnTMP - Pink	ZnTPP - Salmon	FeTFPPCL - Beige
ZnSi ₆ PP - Pink	ZnSi ₇ OHPP - Pink	ZnSi ₈ PP - Light Pink	H ₂ TPP - Light Reddish Beige	H ₂ FPP - Greenish Yellow	Neutral Red - Pink with Brown Center
Methyl Red - Orange	Disperse Orange 25 - Pinkish Orange	Rosolic Acid - Red	Fat Brown RR - Dark	Cyanidin Chloride - Reddish Brown	Metanil Yellow - Light Yellow
Nile Red - Light Purple	Mordant Orange 1 - Light Yellow	3,6-Acridineamine - Yellow	Bromocresol Green - Dark Yellow	Azodipyridine - Yellow	Rosaniline - Pink
Reichardt's Dye - Teal	Acridine Orange Base - Yellow	Crystal Violet - Dark Blue	Thymol Blue - Purple	Congo Red - Dark Red	Malachite Green Carbinol base - Light Blue

Note:

DOW CORNING 704 silicone diffusion pump fluid (Molecular Weight: 484.82, Density: 1.070, CAS Number: 3982-82-9) was added to all porphyrin solutions: 40 µl/ml.

where

SnTPPCL₂ is 5,10,15,20-Tetraphenyl-21H,23H-porphine Tin (W) Dichloride

Molecular Formula: C₄₄H₂₈SnCl₂N₄

Molecular Weight: 802

CAS: 26334-85-0;

CoTPP is 5,10,15,20-Tetraphenyl-21H,23H-porphine Cobalt(II)

Molecular Formula: C₄₄H₂₈CoN₄

Molecular Weight: 671

CAS: 14172-90-8;

CrTPPCL is 5,10,15,20-Tetraphenyl-21H,23H-porphine Chromium(III) Chloride

Molecular Formula: C₄₄H₂₈CrClN₄

Molecular Weight: 700

CAS: 28110-70-5;

MnTPPCL is 5,10,15,20-Tetraphenyl-21H,23H-porphine Manganese(III) Chloride

Molecular Formula: C₄₄H₂₈ClMnN₄

Molecular Weight: 703

CAS: 32195-55-4;

FeTPPCL is 5,10,15,20-Tetraphenyl-21H,23H-porphine Iron (III) Chloride

Molecular Formula: C₄₄H₂₈ClFeN₄

Molecular Weight: 704

CAS: 16456-81-8;

CuTPP is 5,10,15,20-Tetraphenyl-21H,23H-porphine Copper(II)

Molecular Formula: C₄₄H₂₈CuN₄

Molecular Weight: 676

CAS: 14172-91-9;

Zn(C₃F₇)₄P is Meso tetra(heptafluoropropyl)porphine Zinc (II)

Molecular Formula: C₃₂H₈ZnF₂₈N₄

Molecular Weight: 1044;

ZnF₂PP is 5,10,15,20-Tetrakis(2,6-difluorophenyl)-21H, 23H-porphine Zinc(II)

Molecular Formula: C₄₄H₂₀F₈N₄Zn

Molecular Weight: 820;

InTPPCL is 5,10,15,20-Tetraphenyl-21H,23H-porphine Indium(III) Chloride

Molecular Formula: C₄₄H₂₈ClInN₄

Molecular Weight: 763;

ZnTMP is 5,10,15,20-Tetrakis(2,4,6-trimethylphenyl)-21H, 23H-porphine Zinc(II)

Molecular Formula: C₅₆H₅₂N₄Zn

Molecular Weight: 846

CAS: 104025-54-9;

ZnTPP is 5,10,15,20-Tetraphenyl-21H,23H-porphine Zinc (II)

Molecular Formula: C₄₄H₂₈N₄Zn

Molecular Weight: 678

5 CAS: 14074-80-7;

FeTFPPCL is 5,10,15,20-Tetrakis(pentafluorophenyl)-21H, 23H-porphine Iron(III) Chloride

Molecular Formula: C₄₄H₈ClF₂₀FeN₄

Molecular Weight: 1063.85

10 CAS: 36965-71-6;

ZnSi₆PP is 5(phenyl)-10,15,20-trikis(2',6'-disilyloxyphenyl) porphyrinatozinc(II)

Molecular Formula: ZnC₈₀H₁₁₂O₆N₄Si₆

15 Molecular Weight: 1458;

ZnSi₆OHPP is 5,10,15-trikis(2',6'-disilyloxyphenyl)-20-(2'-hydroxy-6'-silyloxyphenyl)porphyrinatozinc(II)

Molecular Formula: ZnC₈₆H₁₂₆O₈N₄Si₇

Molecular Weight: 1604;

ZnSi₈PP is 5,10,15,20-tetrakis(2',6'-disilyloxyphenyl)porphyrinatozinc(II)

Molecular Formula: ZnC₉₂H₁₄₀O₈N₄Si₈

Molecular Weight: 1718;

25 H₂TPP is 5,10,15,20-Tetraphenyl-21H,23H-porphine

Molecular Formula: C₄₄H₃₀N₄

Molecular Weight: 614.75

CAS: 917-23-7;

30 H₂FPP is 5,10,15,20-Tetrakis(pentafluorophenyl)-21H,23H-porphine

Molecular Formula: C₄₄H₁₀F₂₀N₄

Molecular Weight: 974.57

CAS: 25440-14-6;

35 Azodipyridine is 6'-Butoxy-2,6-diamino-3,3'-azodipyridine

Molecular Formula: C₁₄H₁₈N₆O

Molecular Weight: 286.34

CAS: 617-19-6;

40 Rosaniline is Para-Rosaniline Base

Molecular Formula: C₁₉H₁₉N₃O

Molecular Weight: 305.4

CAS: 25620-78-4

45 FIG. 19 illustrates the response of the array described in

FIG. 18 to acetone. As shown in FIG. 18 and summarized in

Table 14 below, the color changes of each dye in response

to acetone are as follows (the exact colors depend, among

other things, upon scanner settings). The color changes are

derived simply by comparing the before exposure and after

exposure colors and subtracting the two images (i.e., the

absolute value of the difference of the red values becomes

the new red value in the color difference map; etc. for green

values and blue values). If there is no change in the red,

green, and blue color values of a dye in the after-exposure

image, then the color difference map will show black (i.e.,

red value=green value=blue value=0).

TABLE 14

(Summarizing the Dyes and Colors in FIG. 19, i.e., "Dye - Color")

SnTPPCL ₂ - Reddish Brown	CoTPP - Lavender	CrTPPCL - Gray	MnTPPCL Pink	FeTPPCL - Black (no change)	CuTPP - Black (no change)
AgTPP - White	NiTPP - Light Teal	InTPPCL - Blue	IrTPPCL - Light Green	ZnTPP - Black (no change)	FeTFPPCL - Dark Dark Cobalt

TABLE 14-continued

(Summarizing the Dyes and Colors in FIG. 19, i.e., "Dye - Color")

ZnSi ₆ PP - Black (no change)	ZnSi ₆ OHPP Aqua	ZnSi ₆ PP - Dark Teal	H ₂ TTP - Green	H ₂ FPP - White Periphery and Blue Center	Alizarin basic - Dark Purple
Me Red - Dark Blue	BCP - Green	BCP basic - Light Green	BTB - Light Green	BTB basic - Dark Blue	Ph Red basic - Royal Blue
Nile Red - Olive	BCG - Tan	BCG basic - Black (no change)	CresRed - Dark Pink	CresRed basic - Blue	CP Red - Gold
R Dye - Light Pink	TB - Brown	TB basic - Green	MeOr - Light Green	MeOr basic - Dark Blue	CP Red basic - Black (no change)

Many modifications and variations may be made in the techniques and structures described and illustrated herein without departing from the spirit and scope of the present invention. Accordingly, the techniques and structures described and illustrated herein should be understood to be illustrative only and not limiting upon the scope of the present invention.

What is claimed is:

1. An artificial nose comprising an array, the array comprising at least a first dye and a second dye deposited directly onto a single support in a predetermined pattern combination, the combination of the dyes in the array having a distinct and direct spectral absorbance or reflectance response to distinct analytes, wherein the first dye is selected from the group consisting of porphyrin, chlorin, chlorophyll, phthalocyanine, and salen and their metal complexes, and the second dye is distinct from the first dye and selected from the group of dyes consisting of acid-base indicator dyes and solvatochromic dyes.

2. The artificial nose of claim 1 wherein the first dye is a metalloporphyrin.

3. The artificial nose of claim 1 wherein the second dye is an acid-base indicator dye.

4. The artificial nose of claim 1 wherein the second dye is a solvatochromic dye.

5. The artificial nose of claim 1 wherein the second dye is selected from the group consisting of Chlorphenol Red, Bromocresol Green, Bromocresol Purple, Bromothymol Blue, Phenol Red, Thymol Blue, Cresol Red, Alizarin, Mordant Orange, Methyl Orange, Methyl Red, Reichardt's Dye, Nile Red, Congo Red, Victoria Blue B, Eosin Blue, Fat Brown B, Benzopurpurin 4B, Phloxine B, Orange G, Metanil Yellow, Naphthol Green B, Methylene Blue, Safranin O, Methylene Violet 3RAX, Sudan Orange G, Morin Hydrate, Neutral Red, Disperse Orange 25, Rosolic Acid, Fat Brown RR, Cyanidin chloride, 3,6-Acridineamine, 6'-Butoxy-2,6-diamino-3,3'-azodipyridine, para-Rosaniline Base, Acridine Orange Base, Crystal Violet, and Malachite Green Carbinol Base.

6. The artificial nose of claim 1 wherein the first dye is a porphyrin and has a periphery and a superstructure bonded to the periphery.

7. A method of detecting an analyte comprising the steps of: forming an array of at least a first dye and a second dye deposited directly onto a single support in a predetermined pattern combination, the combination of the dyes in the array having a distinct and direct spectral absorbance or reflectance response to distinct analytes wherein the first dye is selected from the group consisting of porphyrin, chlorin,

chlorophyll, phthalocyanine, and salen and their metal complexes, and the second dye is distinct from the first dye and selected from the group of acid-base indicator dyes and solvatochromic dyes, subjecting the array to an analyte, inspecting the array for a distinct and direct spectral absorbance or reflectance response, and correlating the distinct and direct spectral response to the presence of the analyte.

8. The method of claim 7 wherein the first dye is a metalloporphyrin.

9. The method of claim 7 wherein the second dye is an acid-base indicator dye.

10. The method of claim 7 wherein the second dye is a solvatochromic dye.

11. The method of claim 7 wherein the second dye is selected from the group consisting of Chlorphenol Red, Bromocresol Green, Bromocresol Purple, Bromothymol Blue, Phenol Red, Thymol Blue, Cresol Red, Alizarin, Mordant Orange, Methyl Orange, Methyl Red, Reichardt's Dye, Nile Red, Congo Red, Victoria Blue B, Eosin Blue, Fat Brown B, Benzopurpurin 4B, Phloxine B, Orange G, Metanil Yellow, Naphthol Green B, Methylene Blue, Safranin O, Methylene Violet 3RAX, Sudan Orange G, Morin Hydrate, Neutral Red, Disperse Orange 25, Rosolic Acid, Fat Brown RR, Cyanidin chloride, 3,6-Acridineamine, 6'-Butoxy-2,6-diamino-3,3'-azodipyridine, para-Rosaniline Base, Acridine Orange Base, Crystal Violet, and Malachite Green Carbinol Base.

12. The method of claim 7 wherein the first dye is a porphyrin and has a periphery and a superstructure bonded to the periphery.

13. An artificial tongue comprising an array, the array comprising at least a first dye and a second dye deposited directly onto a single support in a predetermined pattern combination, the combination of the dyes in the array having a distinct and direct spectral absorbance or reflectance response to distinct analytes in solution or liquid analytes, or analytes in a solid or solid analytes, wherein the first dye is selected from the group consisting of porphyrin, chlorin, chlorophyll, phthalocyanine, and salen and their metal complexes, and the second dye is distinct from the first dye and selected from the group of dyes consisting of acid-base indicator dyes and solvatochromic dyes.

14. The artificial tongue of claim 13 wherein the first dye is a metalloporphyrin.

15. The artificial tongue of claim 13 wherein the second dye is an acid-base indicator dye.

16. The artificial tongue of claim 13 wherein the second dye is a solvatochromic dye.

45

17. The artificial tongue of claim 13 wherein the second dye is selected from the group consisting of Chlorphenol Red, Bromocresol Green, Bromocresol Purple, Bromothymol Blue, Phenol Red, Thymol Blue, Cresol Red, Alizarin, Mordant Orange, Methyl Orange, Methyl Red, Reichardt's Dye, Nile Red, Congo Red, Victoria Blue B, Eosin Blue, Fat Brown B, Benzopurpurin 4B, Phloxine B, Orange G, Methyl Yellow, Naphthol Green B, Methylene Blue, Safranin O, Methylene Violet 3RAX, Sudan Orange G, Morin Hydrate, Neutral Red, Disperse Orange 25, Rosolic Acid, Fat Brown RR, Cyanidin chloride, 3,6-Acridineamine, 6'-Butoxy-2,6-diamino-3,3'-azodipyridine, para-Rosaniline Base, Acridine Orange Base, Crystal Violet, and Malachite Green Carbinol Base.

46

18. The artificial tongue of claim 13 wherein the first dye is a porphyrin and has a periphery and a superstructure bonded to the periphery.

19. The artificial nose of claim 1 further comprising a low volatility liquid.

20. The method of claim 7 further comprising the step of adding a low volatility liquid to the array.

21. The artificial tongue of claim 13 further comprising a low volatility liquid.

22. The method of claim 7 further comprising the step of forming a table of responses of the array to a plurality of distinct analytes.

* * * * *